

PAUL SCHERRER INSTITUT



Universität
Zürich ^{UZH}



WIR SCHAFFEN WISSEN – HEUTE FÜR MORGEN

Andreas Crivellin

PSI & UZH

Anomalies in Particle Physics

DISCRETE 2022, Baden-Baden, 07.11.2022

Work supported by



Outline

- Introduction
- Status of the anomalies
 - $b \rightarrow s \mu \mu$
 - $b \rightarrow c \tau \nu$
 - a_μ
 - Cabibbo Angle Anomaly
 - Non-resonant di-leptons
 - EW fit: W mass and $Z \rightarrow b\bar{b}$
- Explanations of the Flavour anomalies
- Common Explanations
- Conclusions

Physics Beyond the Standard Model

- Dark Matter existence established at cosmological scales
 - New weakly interacting particles
- Neutrinos not exactly massless
 - Right-handed (sterile) neutrinos
- Matter anti-matter asymmetry
 - Additional CP violating interactions

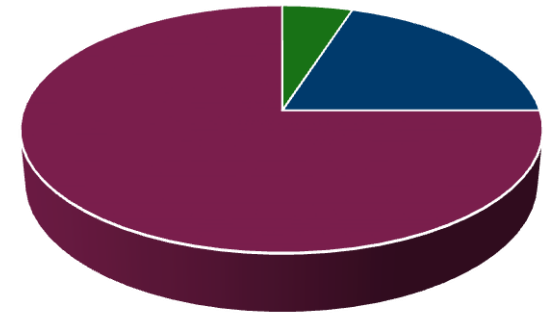

- SM
- Dark Matter
- Dark Energy

The SM must be extended!
What is the underlying fundamental theory?

Discovering New Physics

- **Cosmic Frontier**
 - Cosmic rays and neutrinos
 - Dark Matter
 - Dark Energy
- **Energy Frontier**
 - LHC
 - Future colliders
- **Intensity Frontier**
 - Flavour
 - Neutrino-less double- β decay
 - Test of fundamental symmetries
 - Proton decay

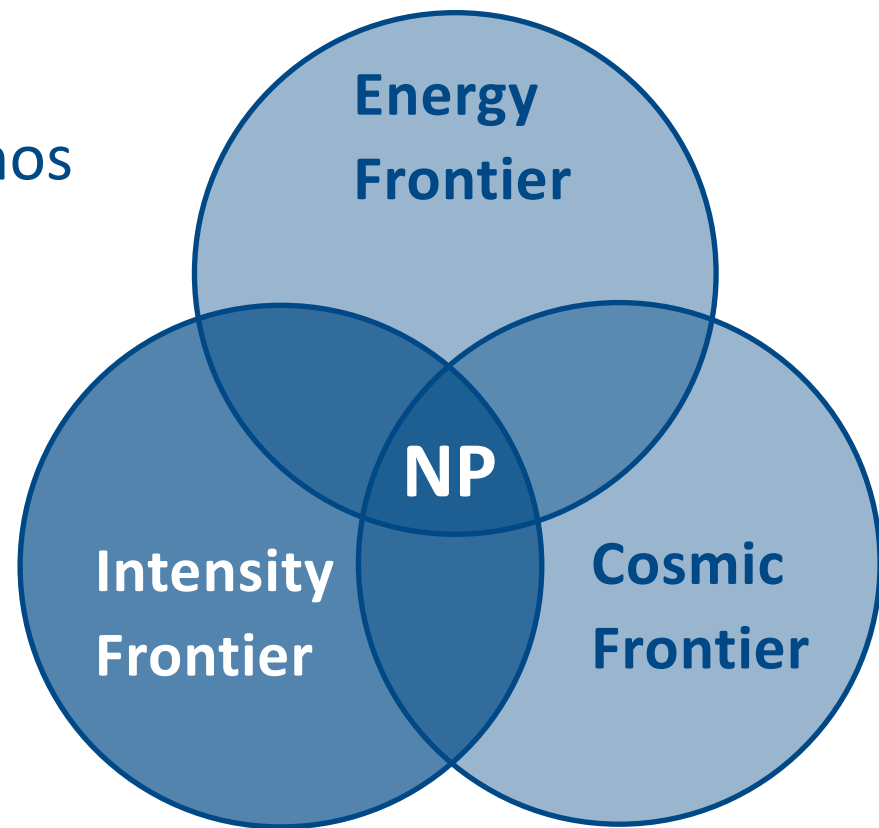

Indirect Searches for New Physics

- Perform high-statistics measurements to search for the quantum effects of new particles

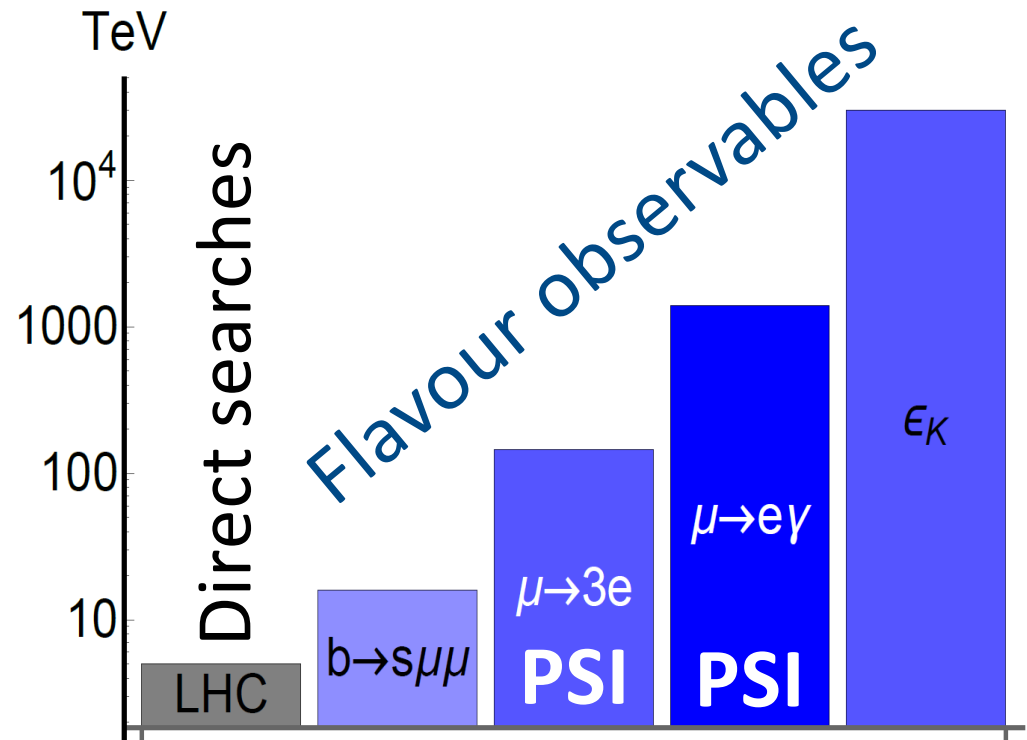
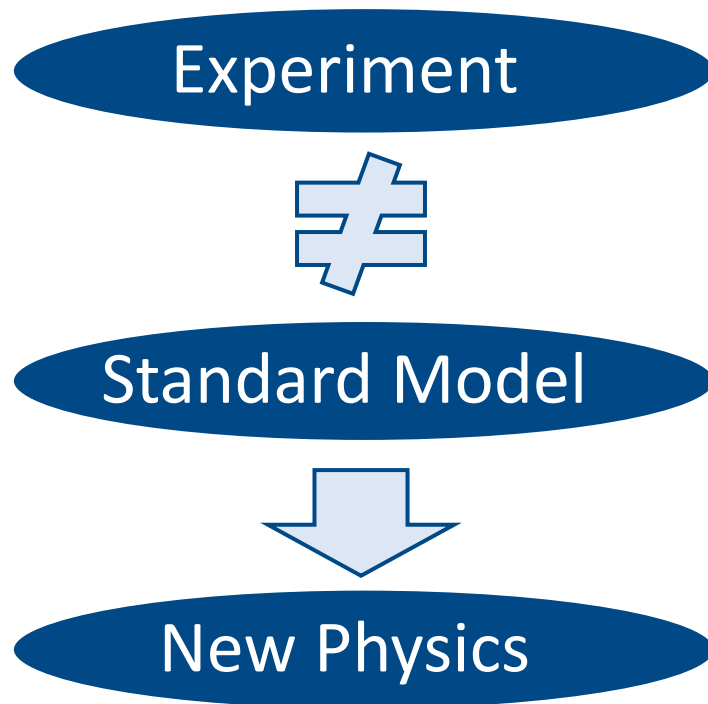

Flavour observables can be sensitive to higher energy scales than collider searches

LFUV in $b \rightarrow s \ell^+ \ell^-$

$$R(K) = \frac{B \rightarrow K \mu^+ \mu^-}{B \rightarrow K e^+ e^-}$$

$$R(K^*) = \frac{B \rightarrow K^* \mu^+ \mu^-}{B \rightarrow K^* e^+ e^-}$$

- Muon and electron masses can be neglected

➡ **Clean prediction**

- Supported by

$$\frac{\Lambda_b \rightarrow K \mu^+ \mu^-}{\Lambda_b \rightarrow K e^+ e^-} = 0.86_{-0.11}^{+0.14} \pm 0.05$$

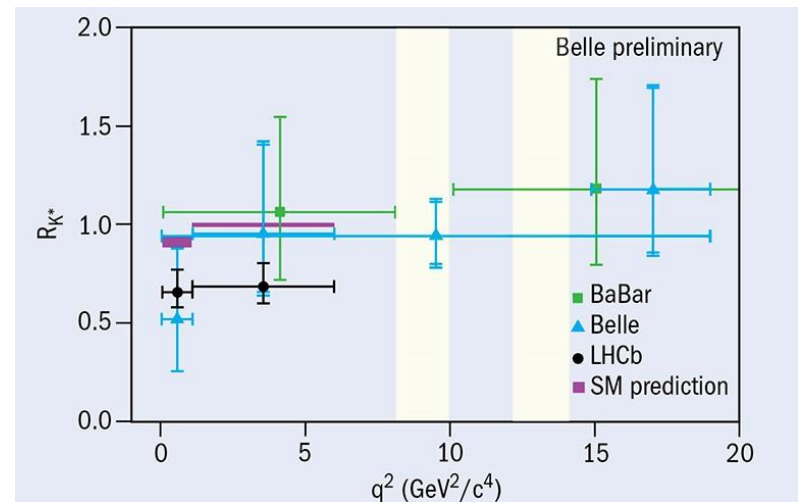
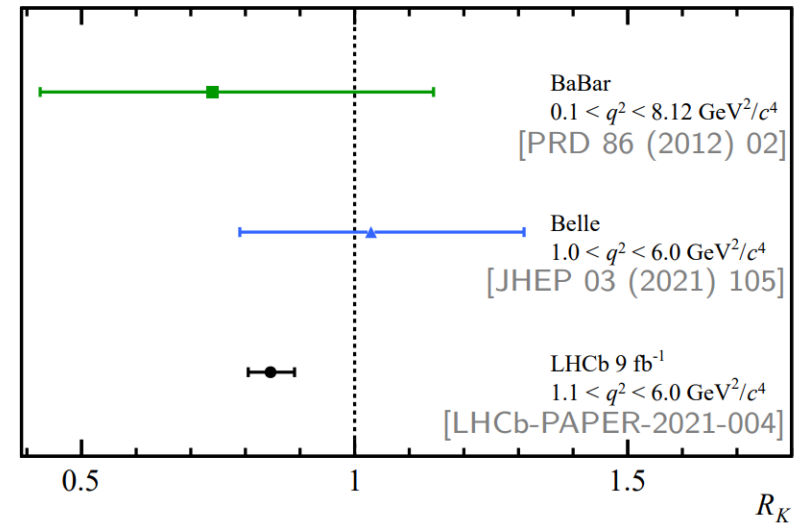

LFUV in B decays $>4\sigma$

Global Fit to $b \rightarrow s \mu^+ \mu^-$ Data

- Perform global model independent fit to include all observables (≈ 180)
- Several NP hypothesis give a good fit to data significantly preferred over the SM hypothesis

$$O_9 = \bar{s} \gamma^\mu P_L b \bar{\ell} \gamma_\mu \ell$$

$$O_{10} = \bar{s} \gamma^\mu P_L b \bar{\ell} \gamma_\mu \gamma^5 \ell$$

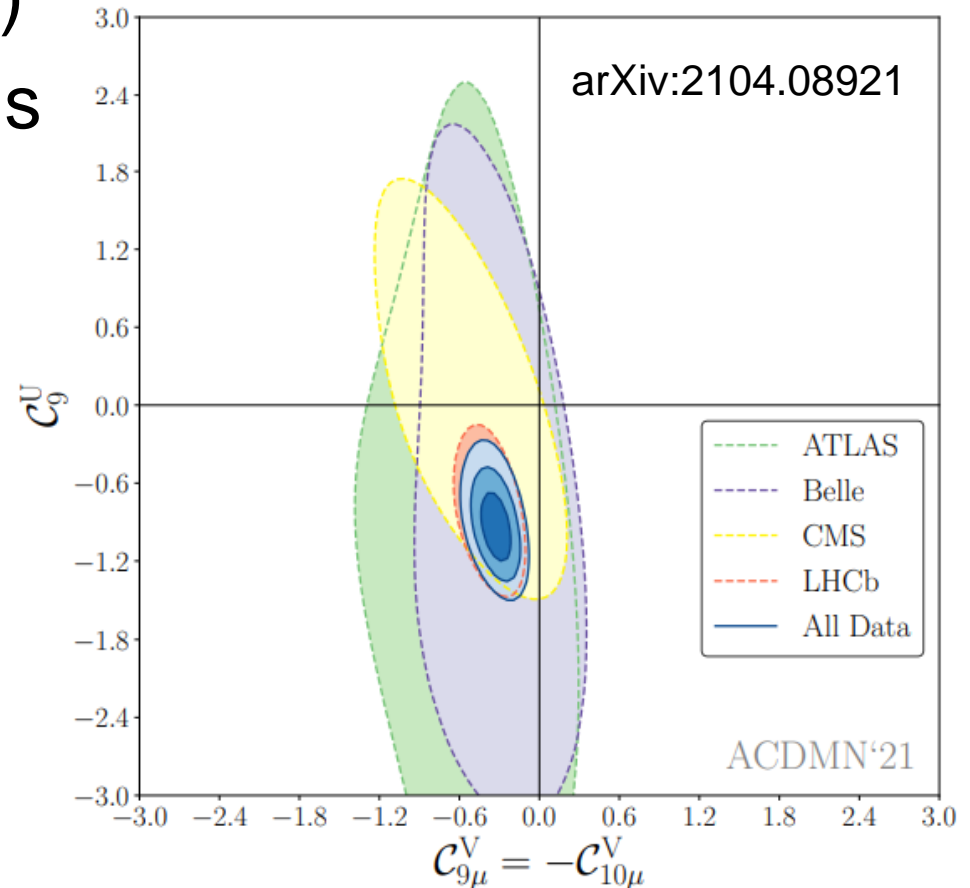

Fit is $>7 \sigma$ better than the SM

$b \rightarrow c \tau \nu$

$$R(D^{(*)}) = B \rightarrow D^{(*)} \tau \nu / B \rightarrow D^{(*)} \ell \nu$$

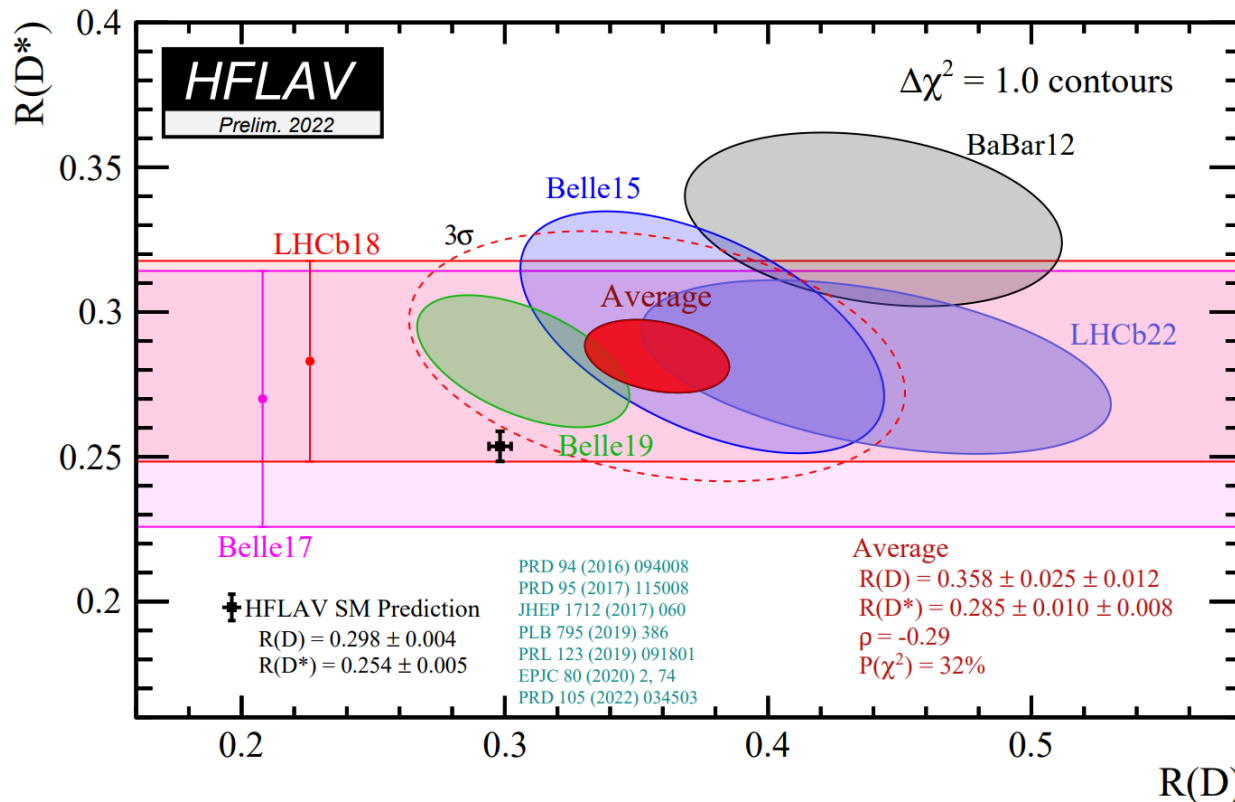

All measurements above the SM prediction
 O(10%) constructive effect at 3 σ preferred

ΔA_{FB} in $B \rightarrow D^* l \nu$

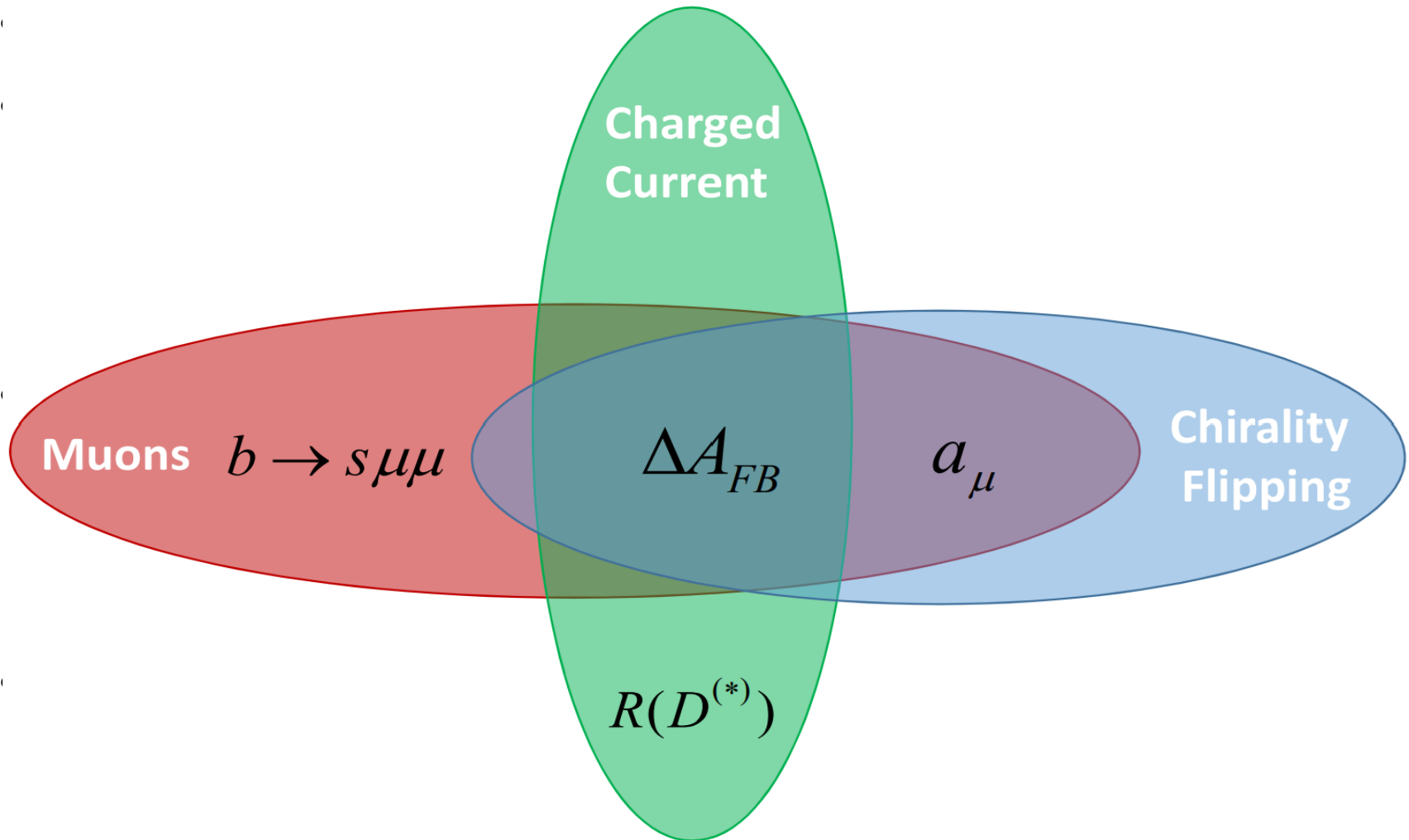

Hint for scalar/tensor NP in $b \rightarrow c \mu \nu$

Muon Anomalous Magnetic Moment

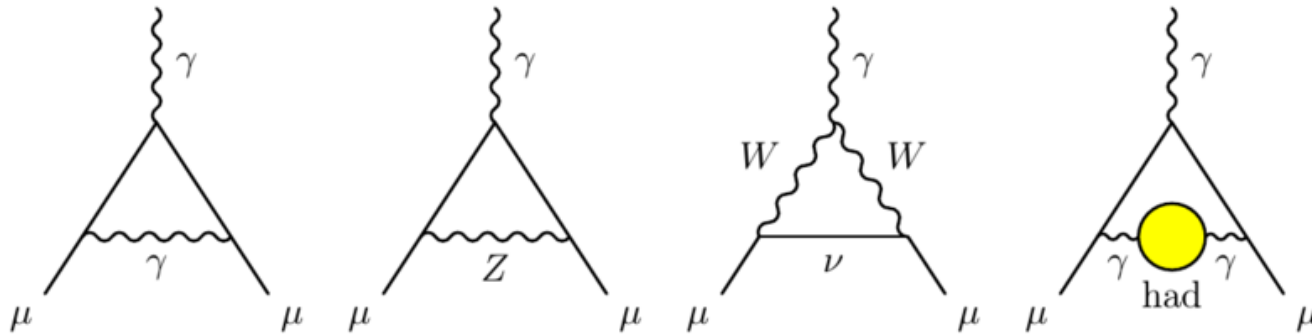

- Theory prediction challenging (hadronic effects)

$$\Delta a_\mu = (251 \pm 49) \times 10^{-11} \quad \text{T. Aoyama et al., arXiv:2006.04822}$$

- Need NP of the order of the SM EW contribution
- Chiral enhancement necessary for heavy NP
- Soon more experimental results from Fermilab
- Vanishes for $m_\mu \rightarrow 0$ \Rightarrow **measure of LFUV**

4.2 σ deviation from the SM prediction

Non-Resonant Di-Leptons

- Excess in di-electrons at $m_{ee} > 1800 \text{ GeV}$
- Observed: 44 events
- Expected 29.2 ± 3.6 events
- Also ATLAS (2006.12946) and HERA (1902.03048) observe slightly more electrons than expected.
- No excess in muon data

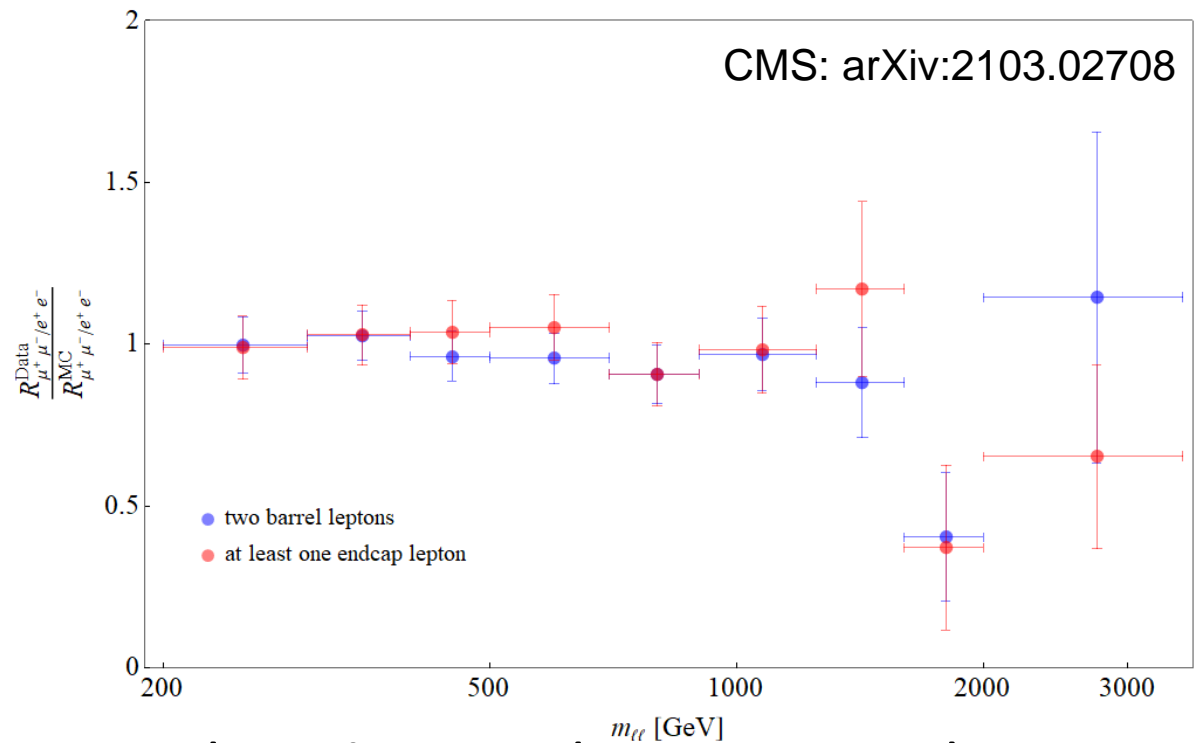

$\approx 3\sigma$ hint for LFUV

Cabibbo Angle Anomaly (CAA)

- Deficit in first row and first column CKM unitarity

$$|V_{ud}^2| + |V_{us}^2| + |V_{ub}^2| = 0.9985 \pm 0.0005$$

$$|V_{ud}^2| + |V_{cd}^2| + |V_{td}^2| = 0.9970 \pm 0.0018$$

(PDG)

AC, Hoferichter, Manzari, PRL 127 (2021)

- NP in the determination of V_{ud} from beta decays needed

- Can be interpreted as

- NP in beta decays
- NP in the Fermi constant
- LFUV (modified $W\mu\nu$ coupling)

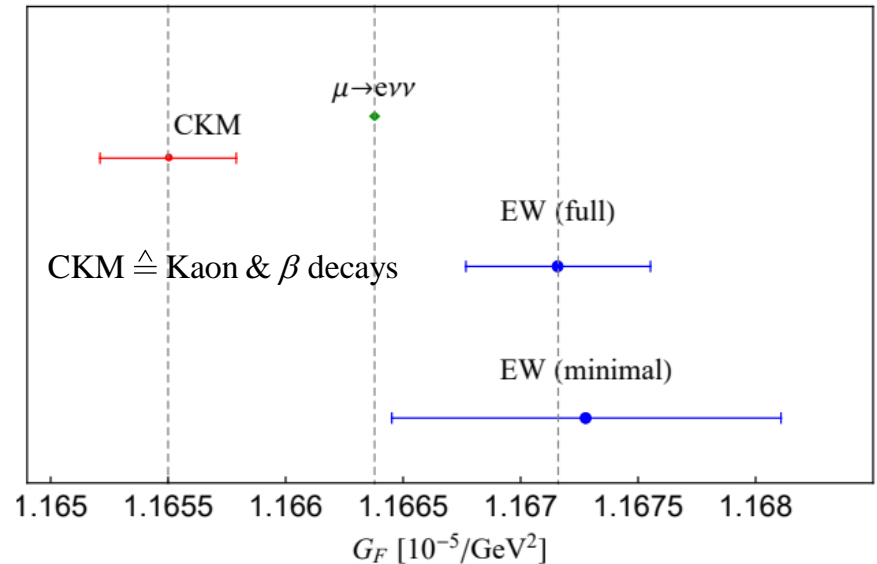

3σ tension, can be interpreted as LFUV

EW fit: W mass and $Z \rightarrow bb$,

- 3.7σ tension in the W mass using a conservative error combination
- 2σ tension in $Z \rightarrow bb$ from LEP

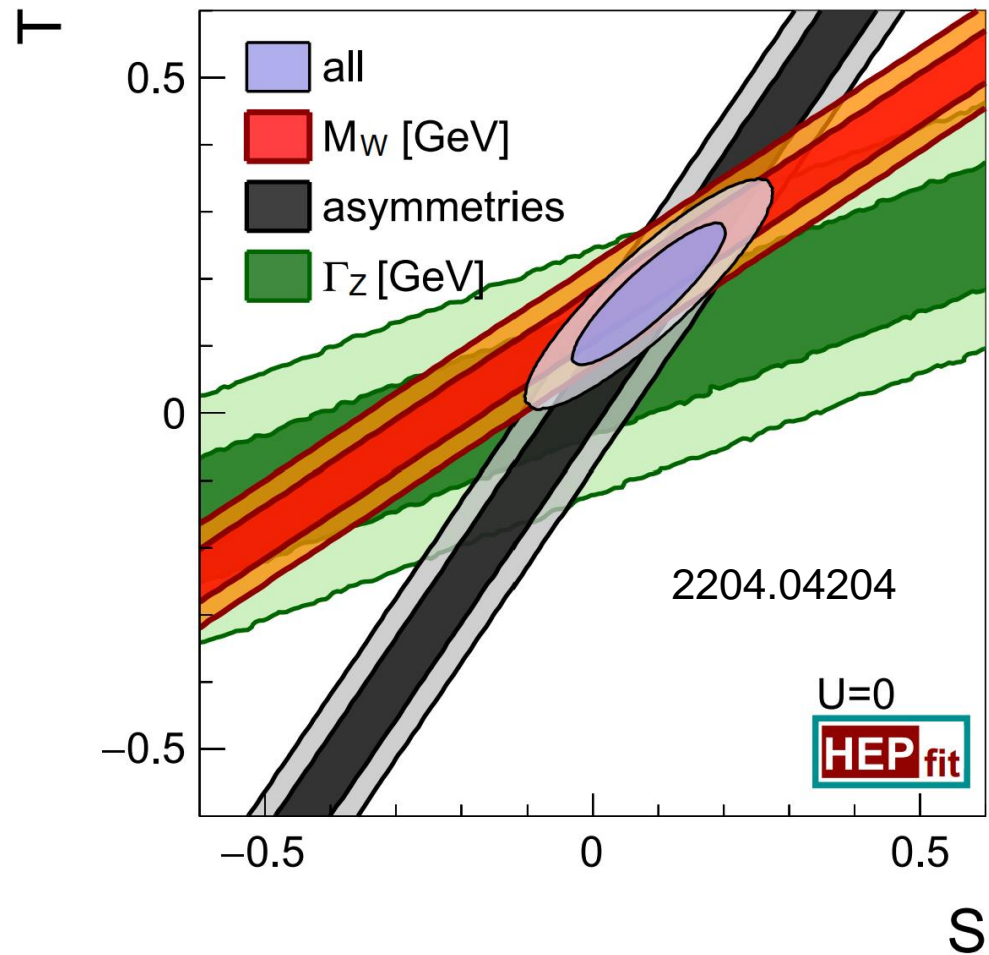

Related to LFUV?

Hints for New Physics

- LFUV AC, M. Hoferichter, Science 374 (2021)

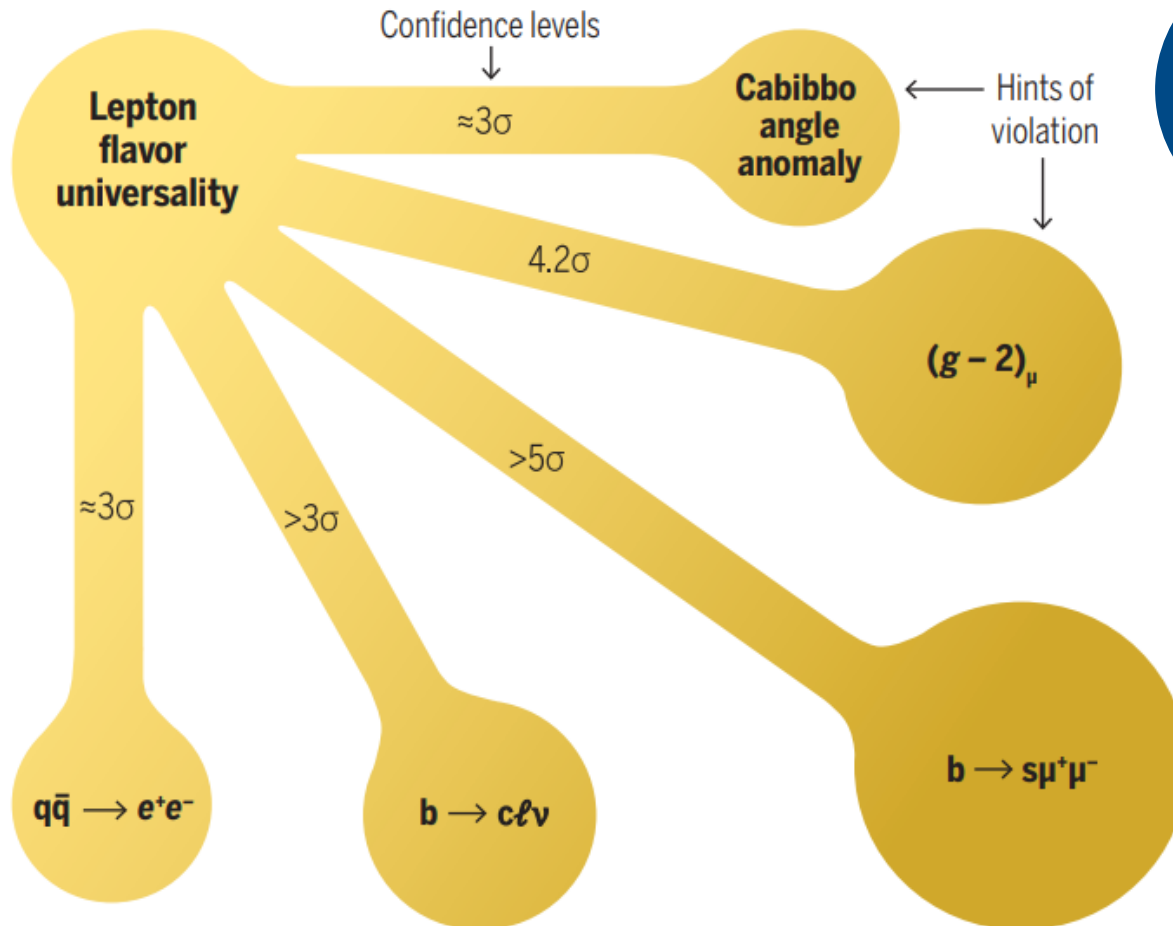

- EW observables

$$m_W \approx 3-4\sigma$$

$$Z \rightarrow b\bar{b}$$

- Direct searches

$$\gamma\gamma$$
$$\tau\tau$$

$$4b$$
$$b\bar{b}\tau\tau$$

Expanations

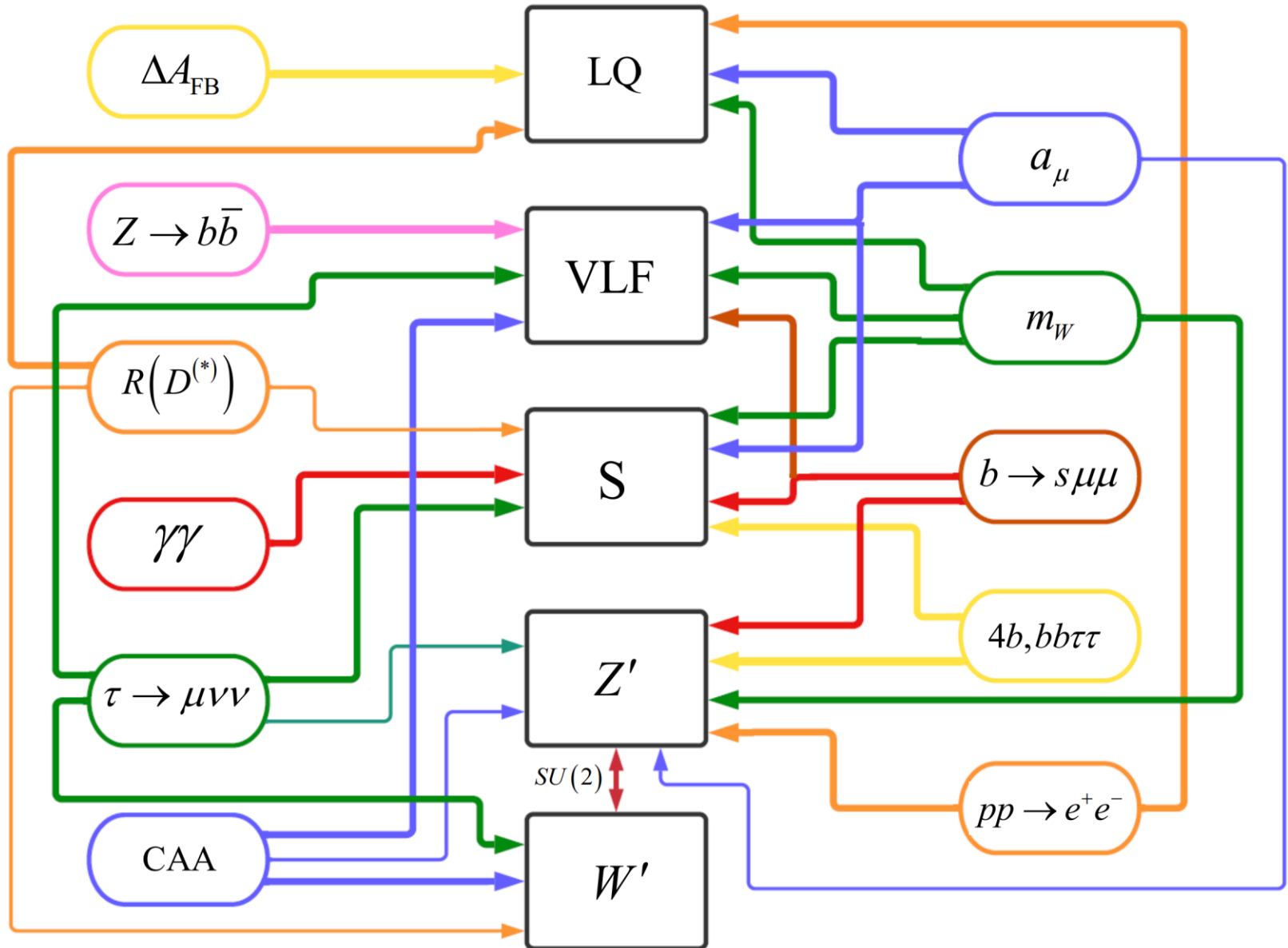

Simultaneous Explanations

Vector Leptoquark SU(2) Singlet

- Left-handed effect in $b \rightarrow s \mu \mu$
- Left-handed vector current in $R(D)$ and $R(D^*)$
- No effect in $b \rightarrow s \nu \nu$
- No proton decay
- Contained within the Pati-Salam model
- Massive vector bosons
 - Non-renormalizable without Higgs mechanism
 - Pati Salam not possible at the TeV scale because of $K_L \rightarrow \mu e$ and $K \rightarrow \pi \mu e$

Good solution, but difficult UV completion

Perfect agreement with data

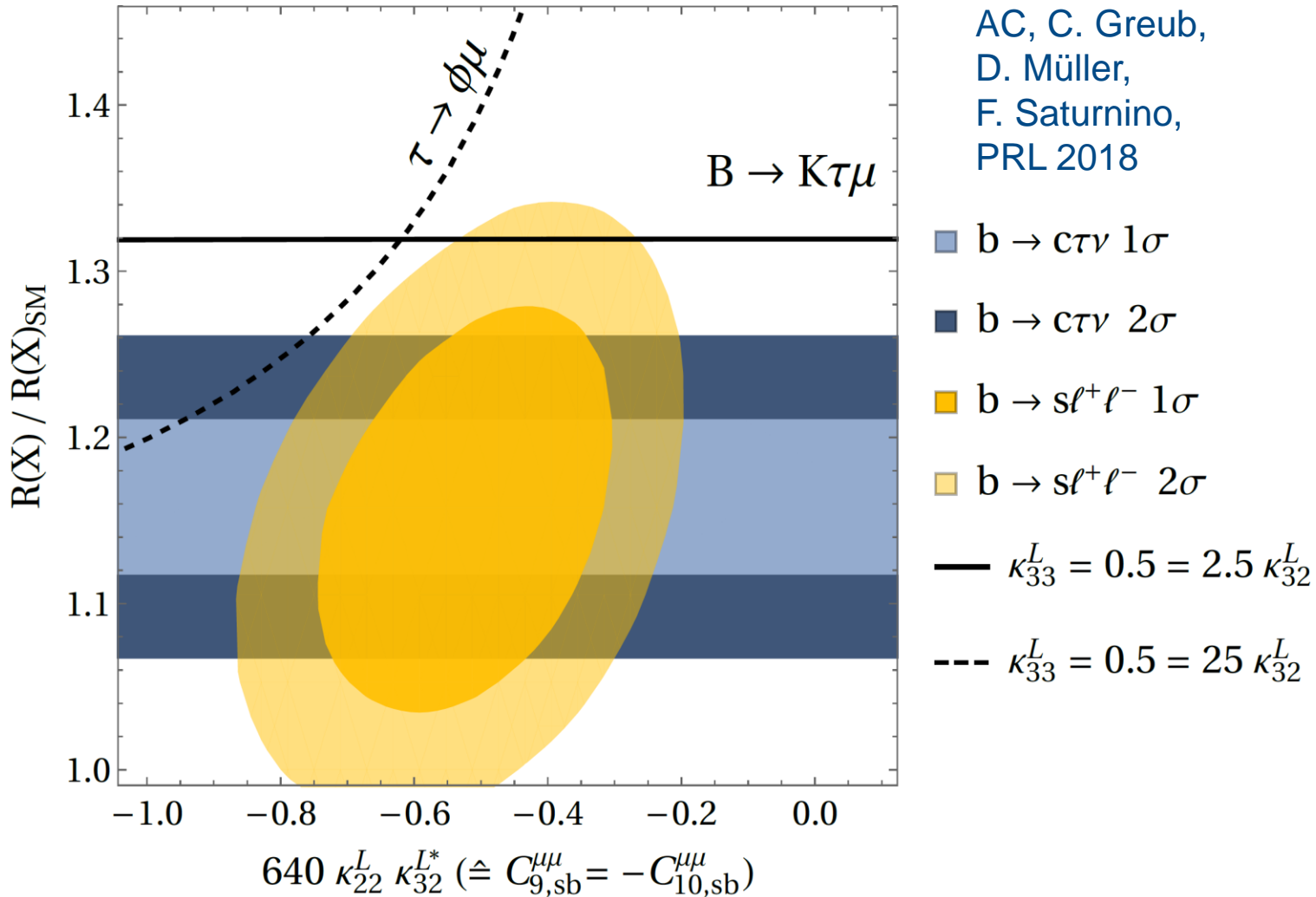

Pati-Salam LQ can explain the flavour anomalies

Model for $b \rightarrow s \ell \ell$, CAA, $Z \rightarrow bb$ & $\tau \rightarrow \mu \nu$

- L_μ - L_τ model with vector-like quarks

AC, C.A. Manzari et al.
PRL 127 2021

	q_L	d_R	u_R	H	ℓ_L	e_R	Q_L	Q_R	D_L	D_R	ϕ^+	S
$SU(3)_c$	3	3	3	1	1	1	3	3	3	3	1	1
$SU(2)_L$	2	1	1	2	2	1	2	2	1	1	1	1
$U(1)_Y$	$\frac{1}{6}$	$-\frac{1}{3}$	$\frac{2}{3}$	$\frac{1}{2}$	$-\frac{1}{2}$	-1	$-\frac{5}{6}$	$-\frac{5}{6}$	$-\frac{1}{3}$	$-\frac{1}{3}$	1	0
$U(1)'$	0	0	0	0	(0, 1, -1)		0	1	1	0	-1	-1

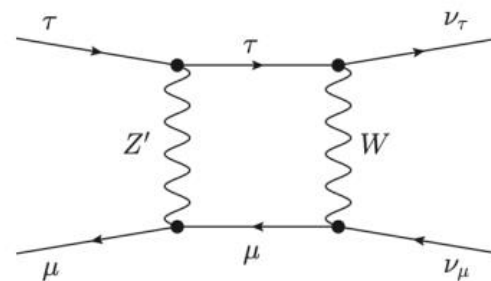
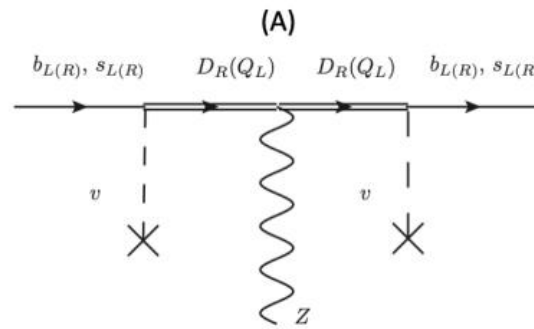
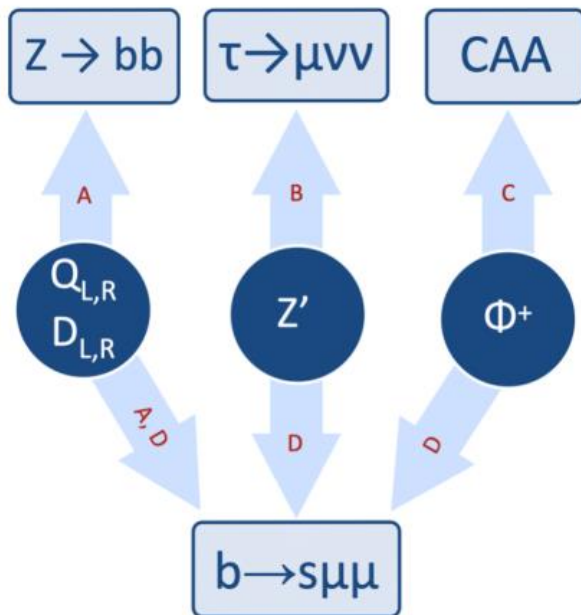

(B)

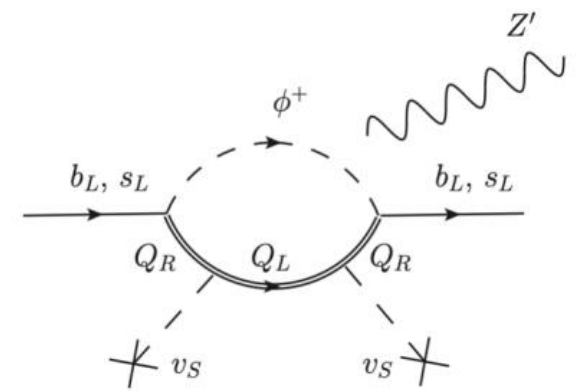
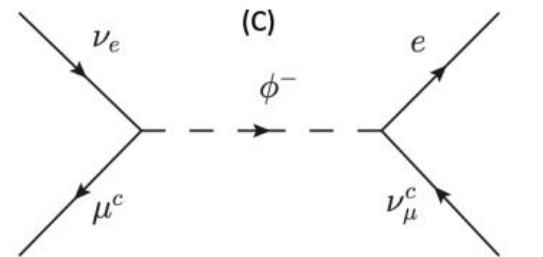

(D)

Simple model provides combined explanation

CAA and Non-Resonant Di-Leptons

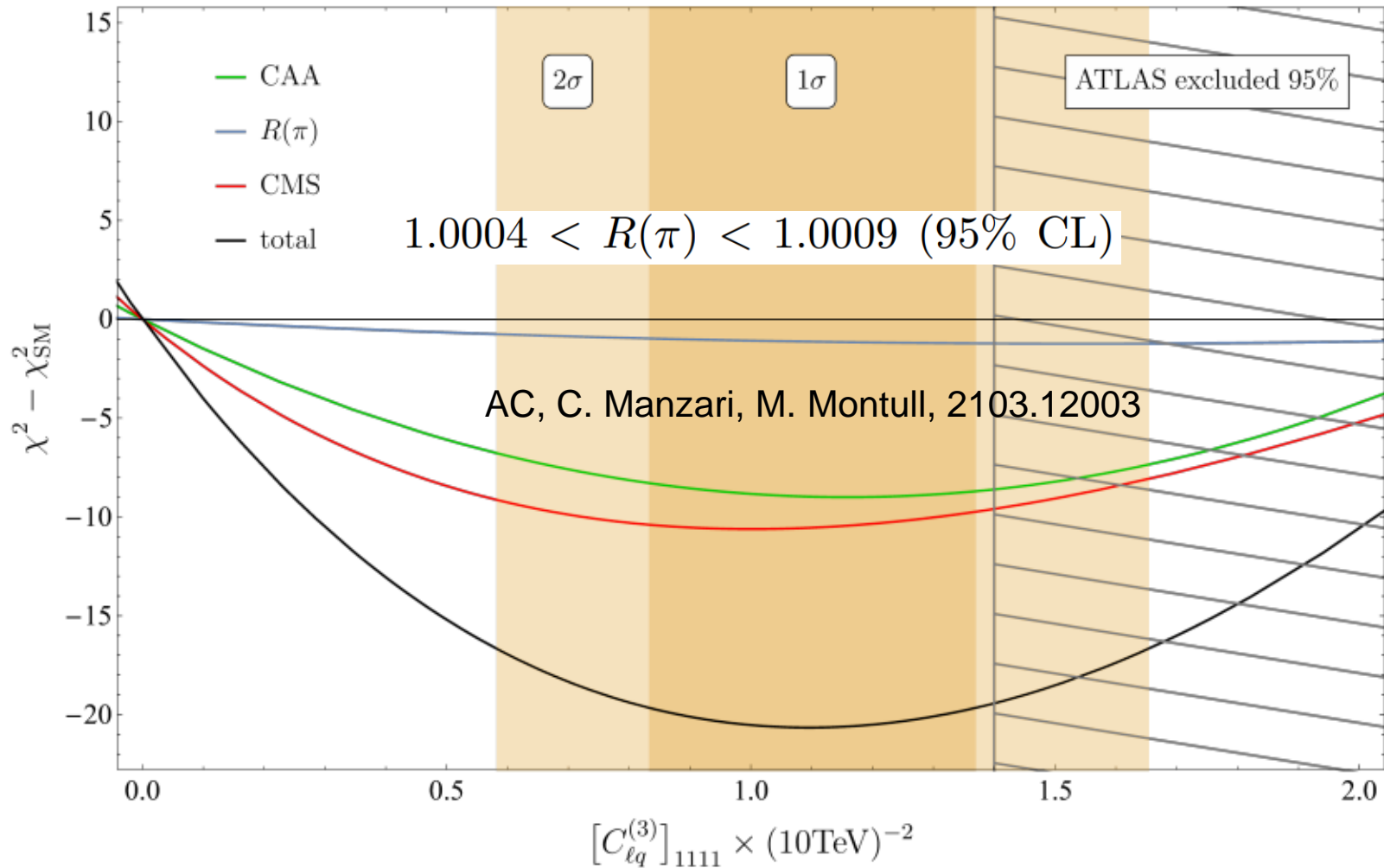

4.5 σ better than SM, prediction for $R(\pi)$

$b \rightarrow s \ell \ell$, W mass and Z' mixing

- Z - Z' mixing can lead to a shift in the predictions of the W mass and can explain the tension in the EW fit

➡ LFU effect in $b \rightarrow s \ell \ell$

Interesting correlations between $b \rightarrow s \ell \ell$ and the EW fit

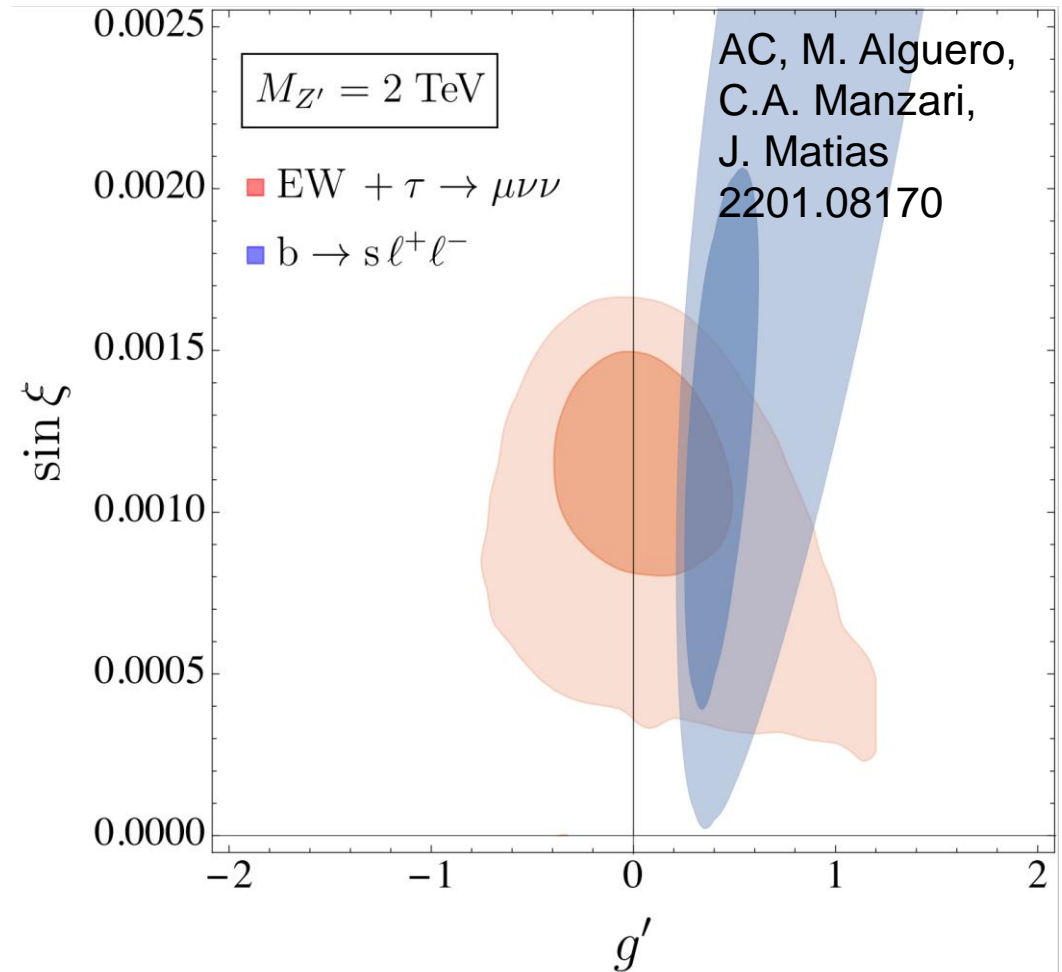

- ATLAS excess in di-jets searches
- Agrees with the di-jet mass of the CMS analysis

- $Y \rightarrow XX$
- Global significance 3.6σ
- New

2.4TeV particle in RS setup

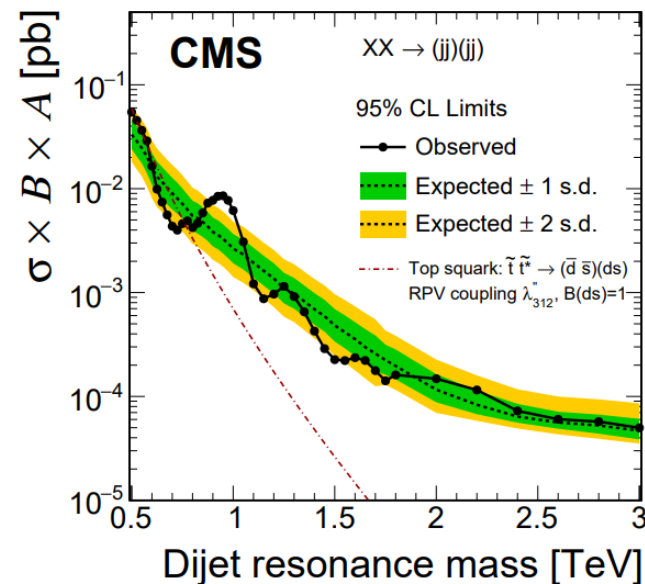
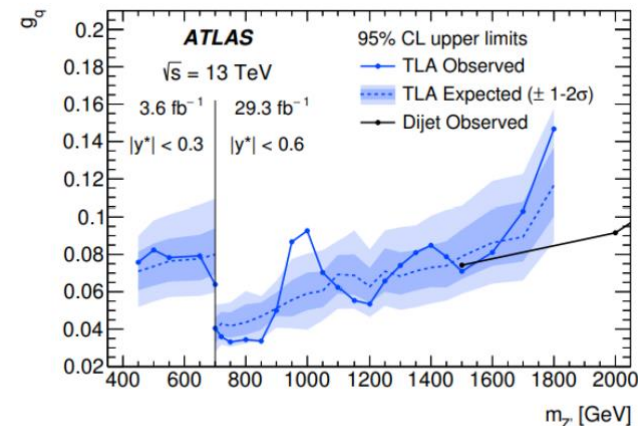
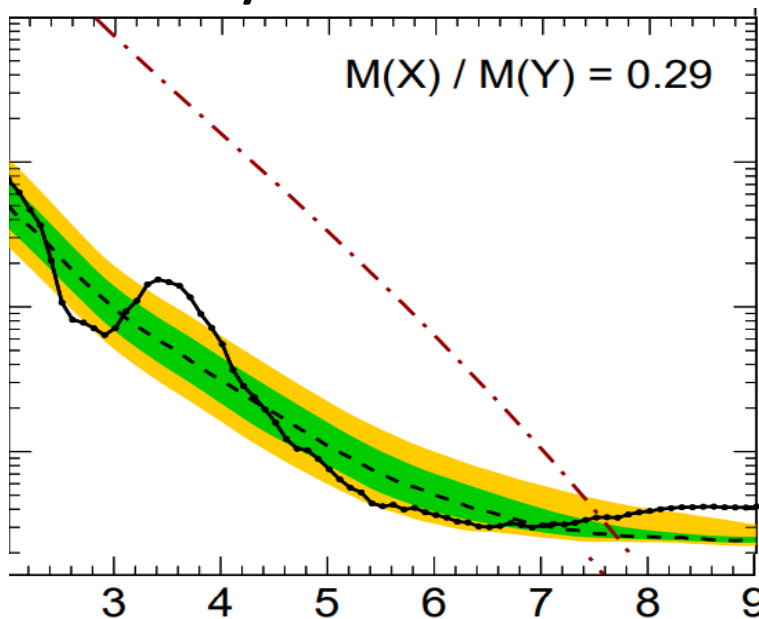

New Heavy Gluons?

Conclusions

- Many intriguing anomalies emerged in the last years:
 - LFUV
 - EW observables
 - Direct LHC searches

The Standard Model is crumbling

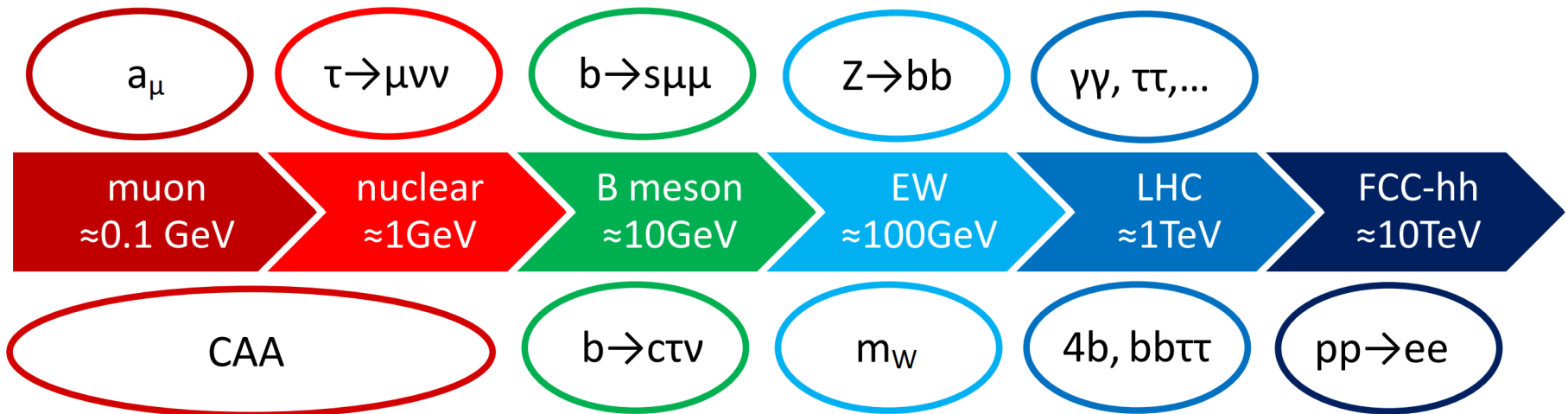

Backup

Model for $b \rightarrow s \ell \ell$, CAA, $Z \rightarrow bb$ and $\tau \rightarrow \mu \nu \nu$

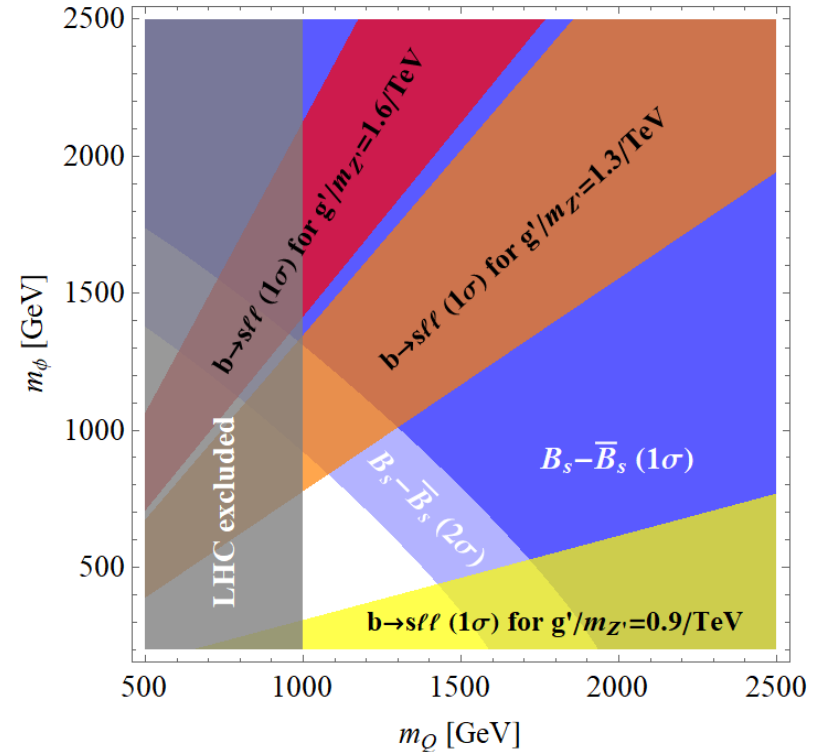
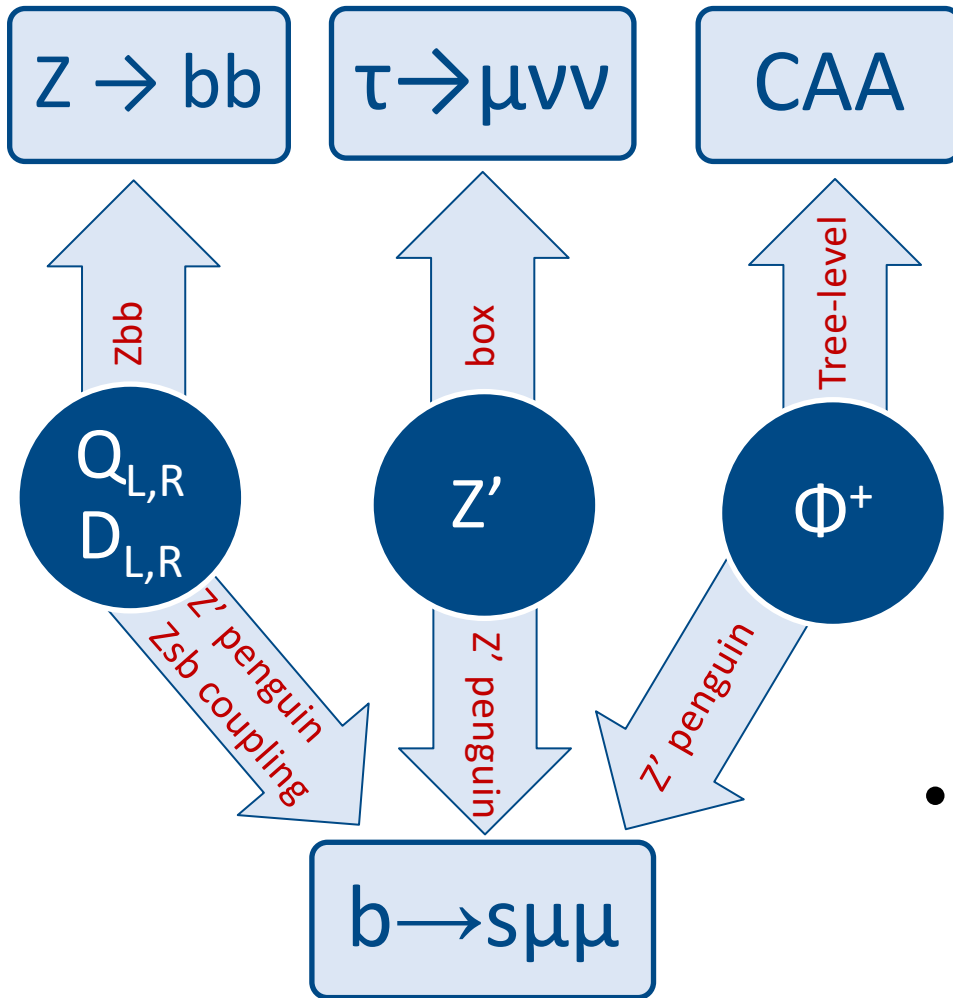

- Z' penguin + modified Z_{sb} coupling give very good fit to $b \rightarrow s \ell \ell$ data

Simple model provides combined explanation

Implications for FCC-ee

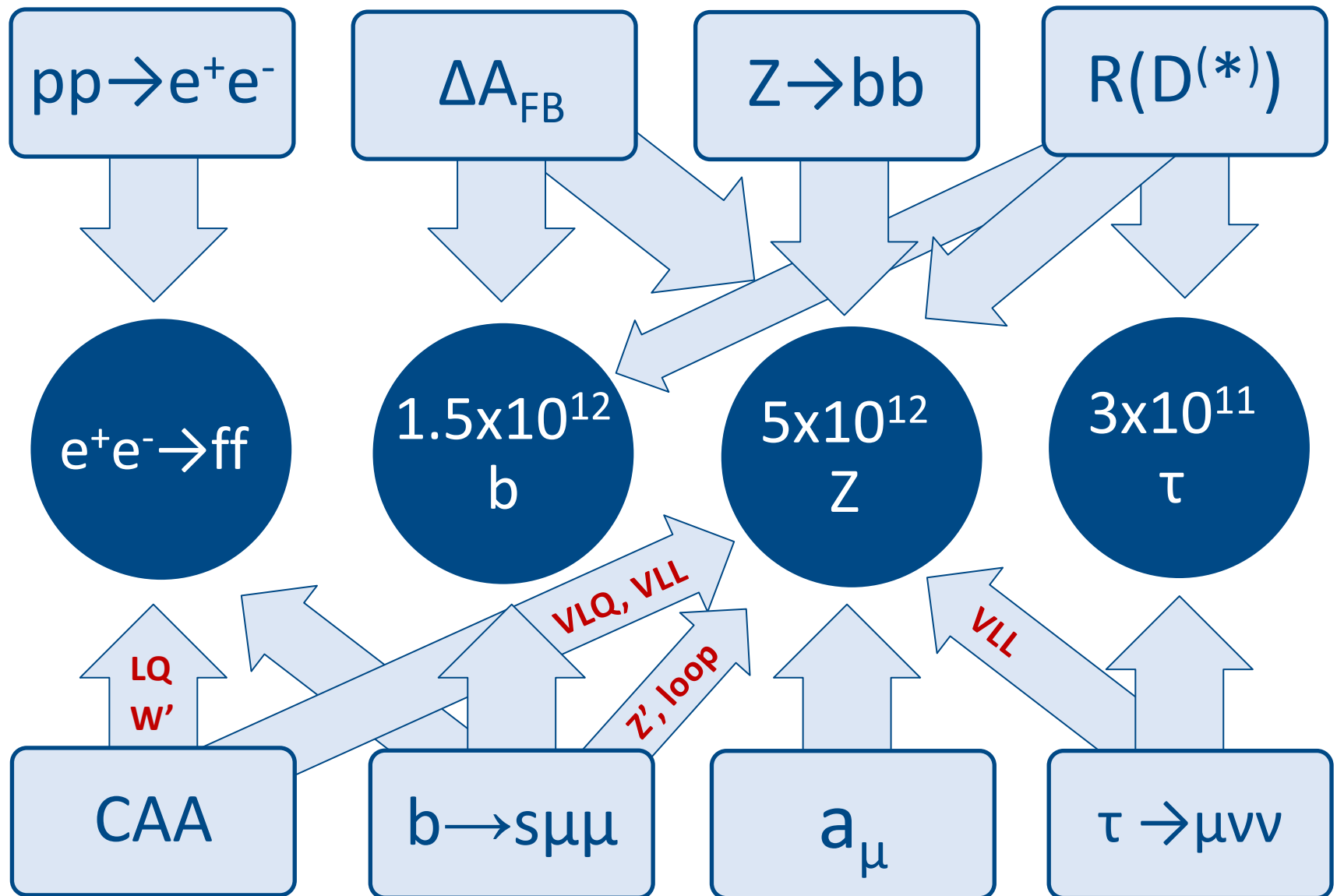

Outlook: Physics at Future Colliders

- Flavour Anomalies require NP at the TeV scale
 - ➡ Direct Searches at HL-LHC, HE-LHC, FCC-pp
- This new particles in general also affect EW precision observables
 - ➡ Z decays at CLIC and FCC-ee
- Flavour is directly linked to the Higgs boson
 - ➡ CLIC, FCC

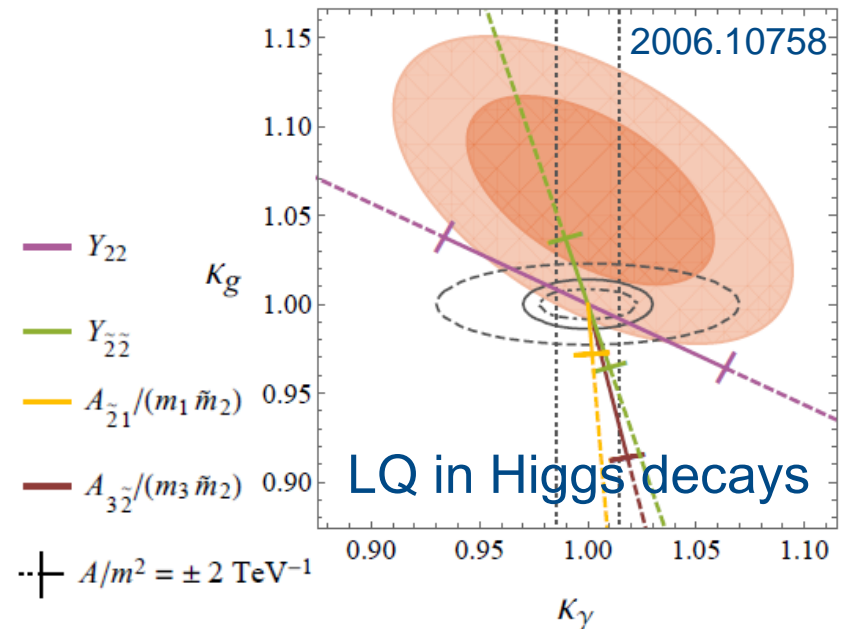

Flavour Anomalies (if confirmed) strengthen the physics case for future colliders significantly

Z' model with U(2) flavour

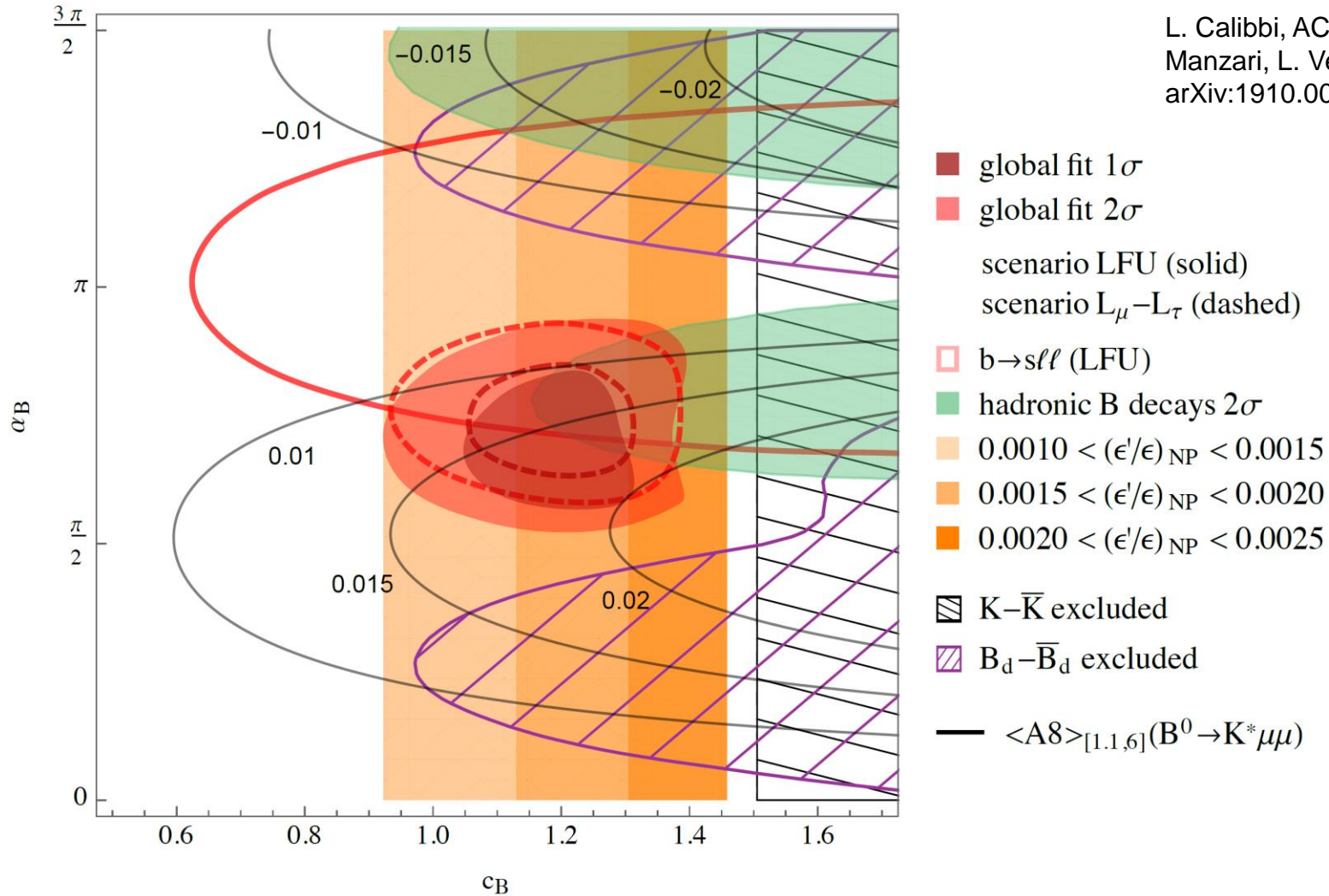

L. Calibbi, AC, F. Kirk, C. A. Manzari, L. Vernazza.
arXiv:1910.00014

Common explanation possible

- ε : indirect CP violation in Kaon decays
 - K_L and K_S are not CP eigenstates due to mixing
- ε' : direct CP violation in Kaon decays

$$\eta_{00} = \frac{A(K_L \rightarrow \pi^0 \pi^0)}{A(K_S \rightarrow \pi^0 \pi^0)}, \quad \eta_{+-} = \frac{A(K_L \rightarrow \pi^+ \pi^-)}{A(K_S \rightarrow \pi^+ \pi^-)}$$

$$\eta_{00} = \varepsilon - \frac{2\varepsilon'}{1 - \sqrt{\omega}} \simeq \varepsilon - 2\varepsilon', \quad \eta_{+-} = \varepsilon + \frac{\varepsilon'}{1 + \omega/\sqrt{2}} \simeq \varepsilon + \varepsilon'$$

$$(\varepsilon'/\varepsilon)_{\text{SM}} = (1.9 \pm 4.5) \times 10^{-4}, \quad \text{Buras et al.}$$

$$(\varepsilon'/\varepsilon)_{\text{exp}} = (16.6 \pm 2.3) \times 10^{-4}$$

Measurement $\approx 3\sigma$ above the SM prediction

- Longstanding $B \rightarrow \pi K$ Puzzle

$$\Delta A_{\text{CP}}^- \equiv A_{\text{CP}}(B^- \rightarrow \pi^0 K^-) - A_{\text{CP}}(\bar{B}^0 \rightarrow \pi^+ K^-)$$

$$\Delta A_{\text{CP}}^- |_{\text{exp}} = (12.4 \pm 2.1)\%$$

$$\Delta A_{\text{CP}}^- |_{\text{SM}} = (1.8^{+4.1}_{-3.2})\%$$

- More observables like

$$A_{\text{CP}}[B_s \rightarrow K^+ K^-]_{\text{exp}} = (-20.0 \pm 6.0 \pm 2.0)\%$$

$$A_{\text{CP}}[B_s \rightarrow K^+ K^-]_{\text{SM}} = (-5.9^{+26.6}_{-5.1})\%$$

$$\text{Br}[B_s \rightarrow \phi \rho^0]_{\text{exp}} = (2.7 \pm 0.7 \pm 0.2 \pm 0.2) \times 10^{-7}$$

$$\text{Br}[B_s \rightarrow \phi \rho^0]_{\text{SM}} = (5.3^{+1.8}_{-1.3}) \times 10^{-7}$$

CP and
isospin
violation
needed

Similar
picture
in D decays

Global fit to data: $2-3\sigma$

ε'/ε explanations

- W_R coupling

V. Cirigliano, et al. arXiv:1612.03914

- Z' (also for ΔA_{CP})

A. Buras, et al.

arXiv:1507.08672

A. Buras and F. De Fazio,

arXiv:1512.02869

- MSSM

T. Kitahara, U. Nierste,

P. Tremper, arXiv:1604.07400

M. Endo, et al. arXiv:1608.01444

A. Crivellin, G. D'Ambrosio,

T. Kitahara and U. Nierste,

arXiv:1703.05786

 LHC excluded

 ε'/ε

$$K_L \rightarrow \pi\nu\nu / K_L \rightarrow \pi\nu\nu_{SM}$$

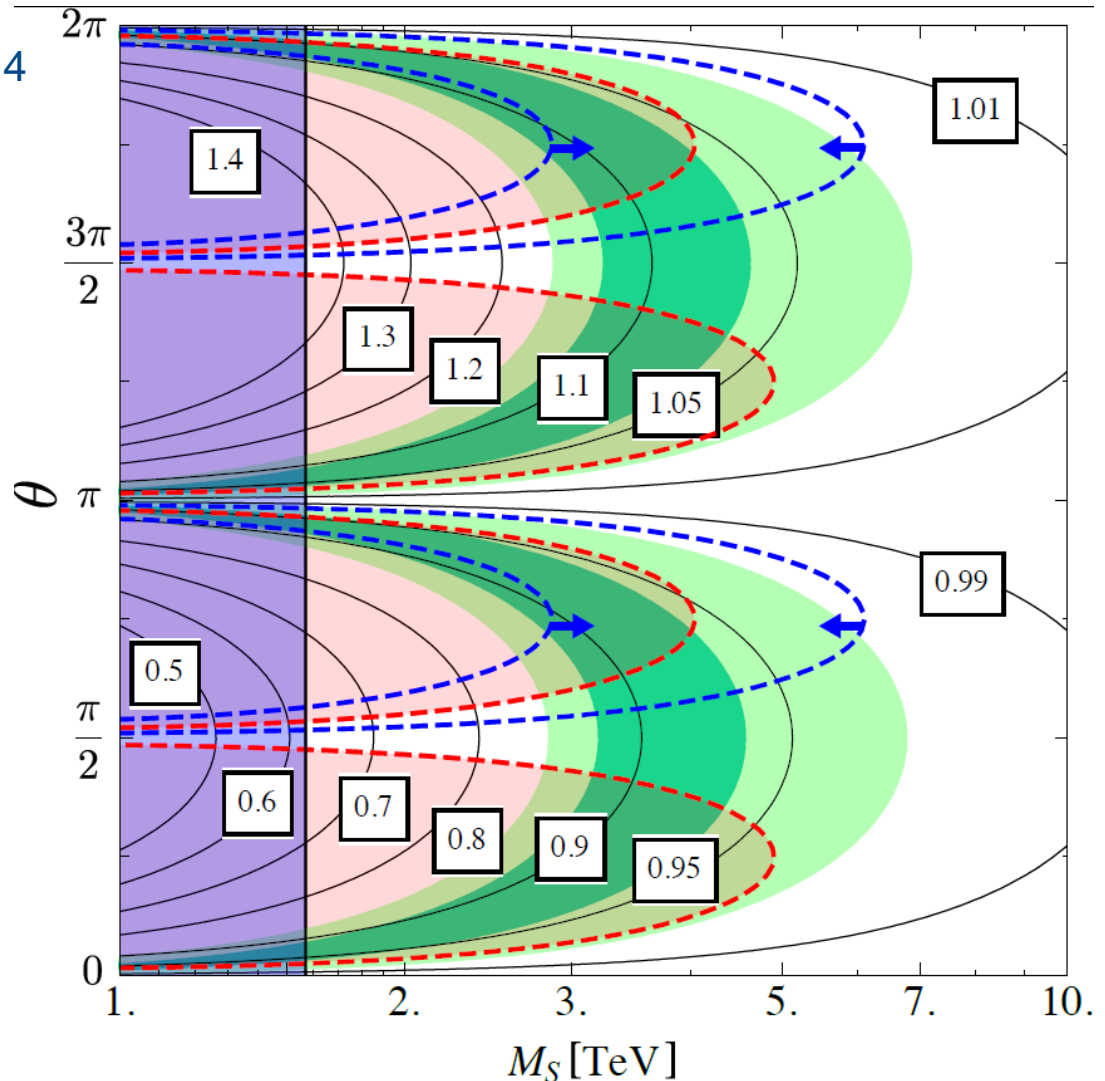

QCD corrections to the Matching

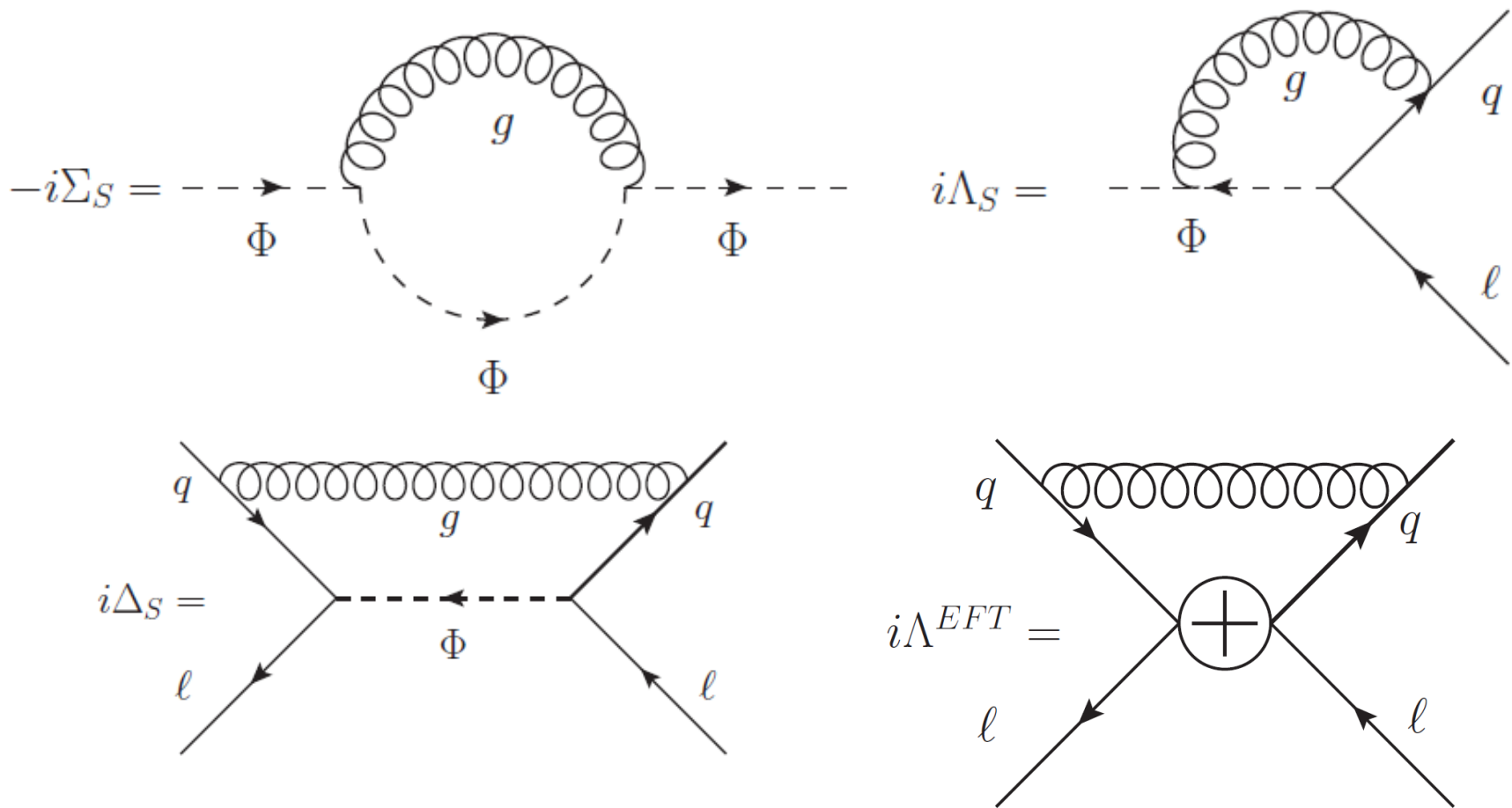

- Perform matching
- Correct for 4-dimensional Fierz identities

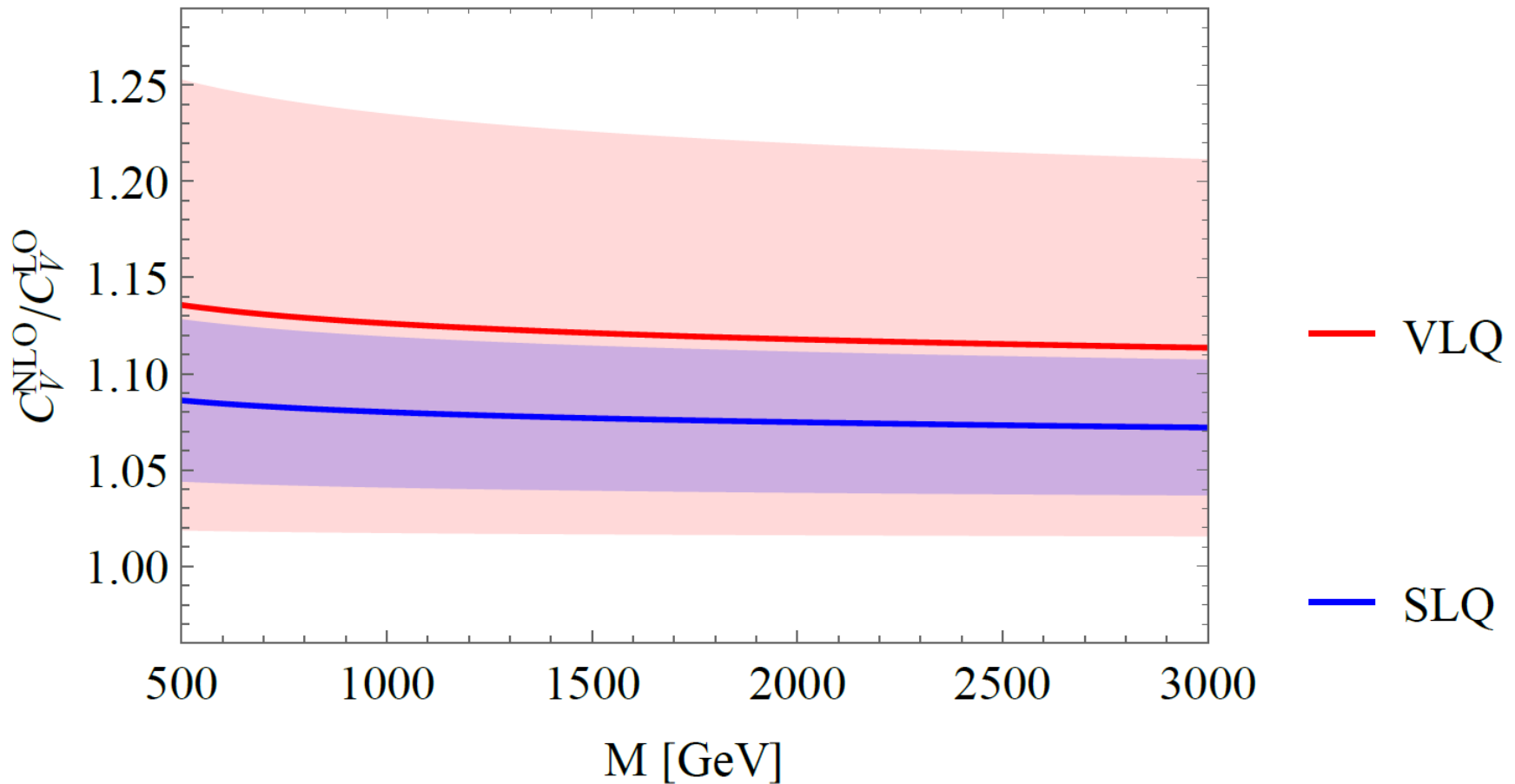

J. Aebischer, AC, C. Greub, 1811.08907

Slightly weaker LHC constraints

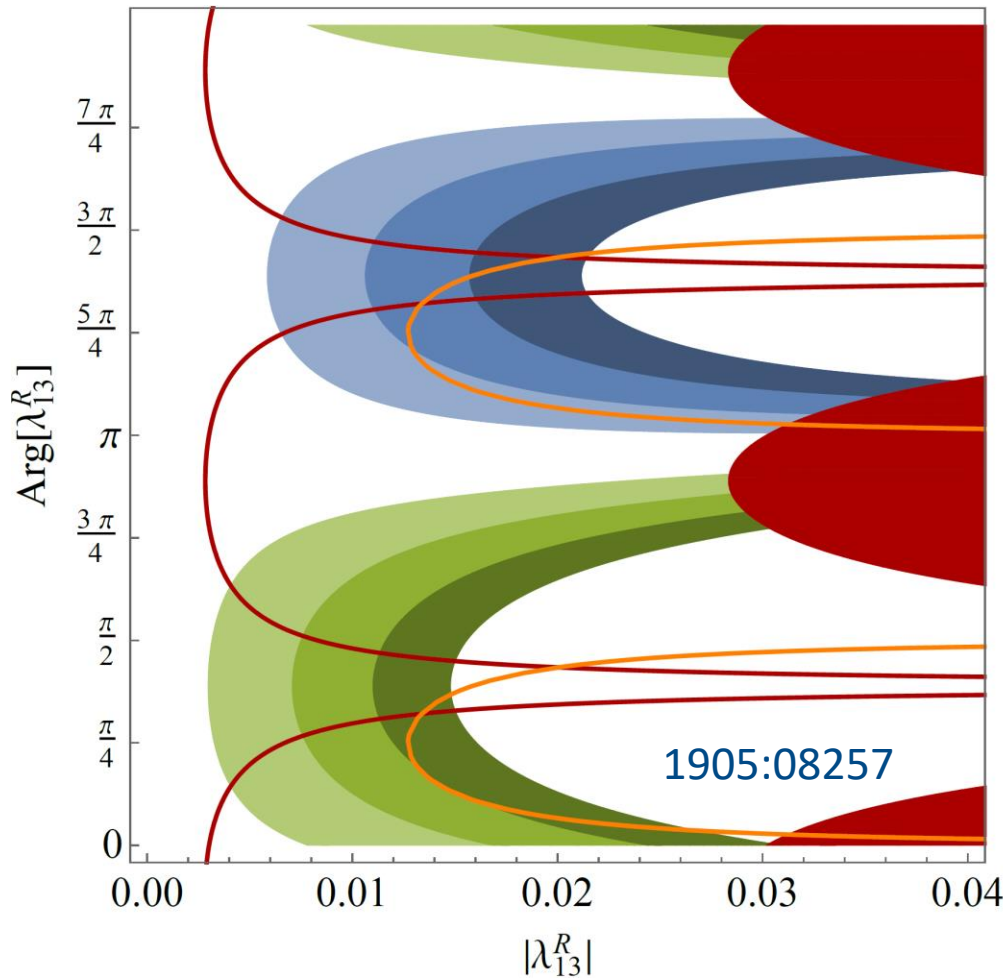

W. Dekens, J. de Vries, M. Jung,
K. K. Vos, arXiv:1809.09114

AC, F. Saturnino

arxiv:1905:08257

- $0.6 < \text{Br}[B \rightarrow \tau \nu] / \text{Br}[B \rightarrow \tau \nu]_{\text{SM}} < 0.7$
- $0.7 < \text{Br}[B \rightarrow \tau \nu] / \text{Br}[B \rightarrow \tau \nu]_{\text{SM}} < 0.8$
- $0.8 < \text{Br}[B \rightarrow \tau \nu] / \text{Br}[B \rightarrow \tau \nu]_{\text{SM}} < 0.9$
- $1.1 < \text{Br}[B \rightarrow \tau \nu] / \text{Br}[B \rightarrow \tau \nu]_{\text{SM}} < 1.2$
- $1.2 < \text{Br}[B \rightarrow \tau \nu] / \text{Br}[B \rightarrow \tau \nu]_{\text{SM}} < 1.3$
- $1.3 < \text{Br}[B \rightarrow \tau \nu] / \text{Br}[B \rightarrow \tau \nu]_{\text{SM}} < 1.4$

■ nEDM excluded

n2EDM sensitivity

$D^0 - \bar{D}^0$ HL-LHC

Effect in B predicts measurable nEDM effect

$R(D^{(*)})$, $b \rightarrow svv$ with 2 Scalar LQs

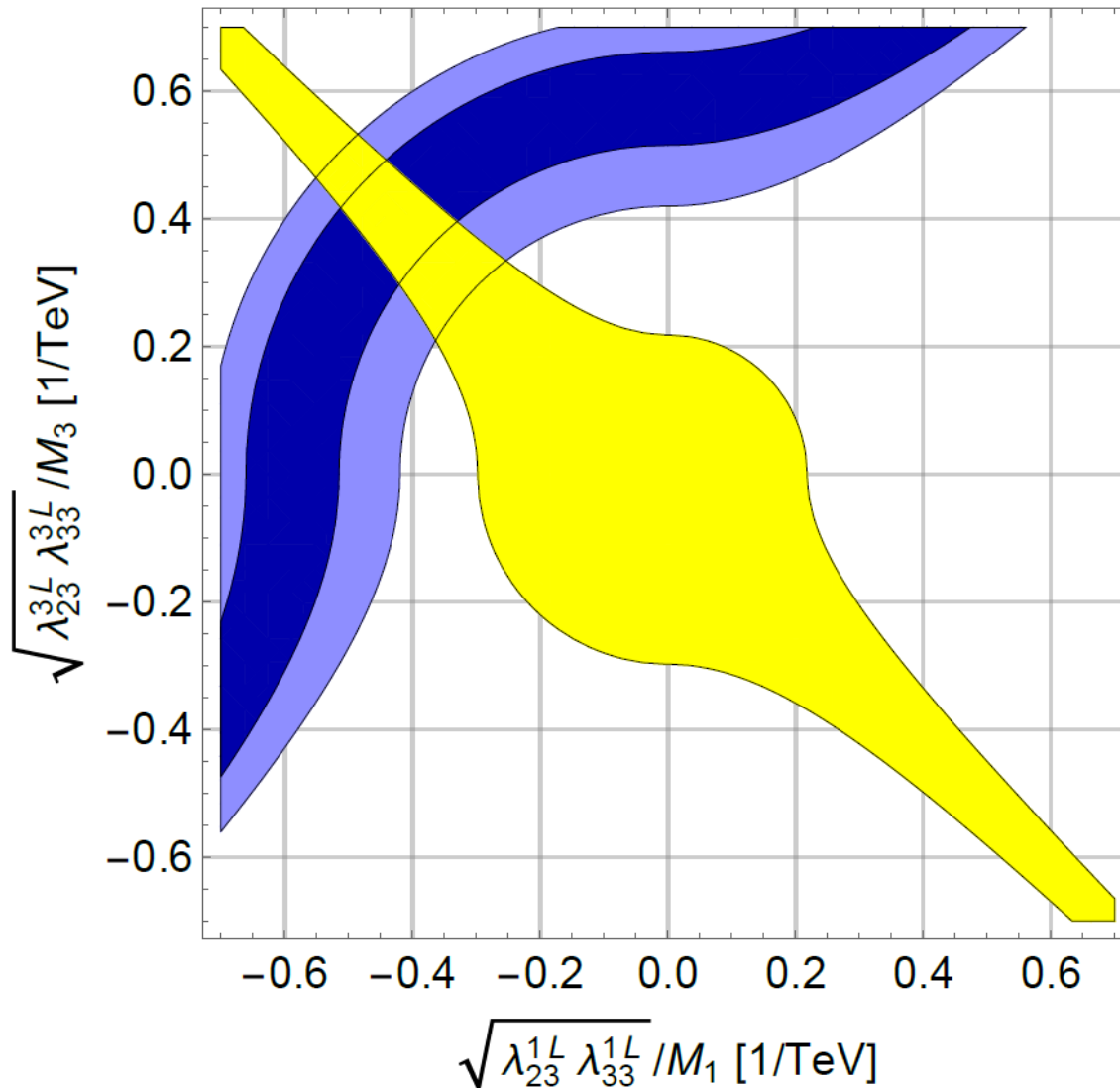

- $R(D^{(*)})$ 2σ
- $R(D^{(*)})$ 1σ
- $b \rightarrow svv$ allowed

$$\lambda_{jk}^L \equiv \lambda_{jk}^{1L}$$

$$\lambda_{jk}^{3L} = e^{i\pi j} \lambda_{jk}^L$$

Model with new vector-like leptons

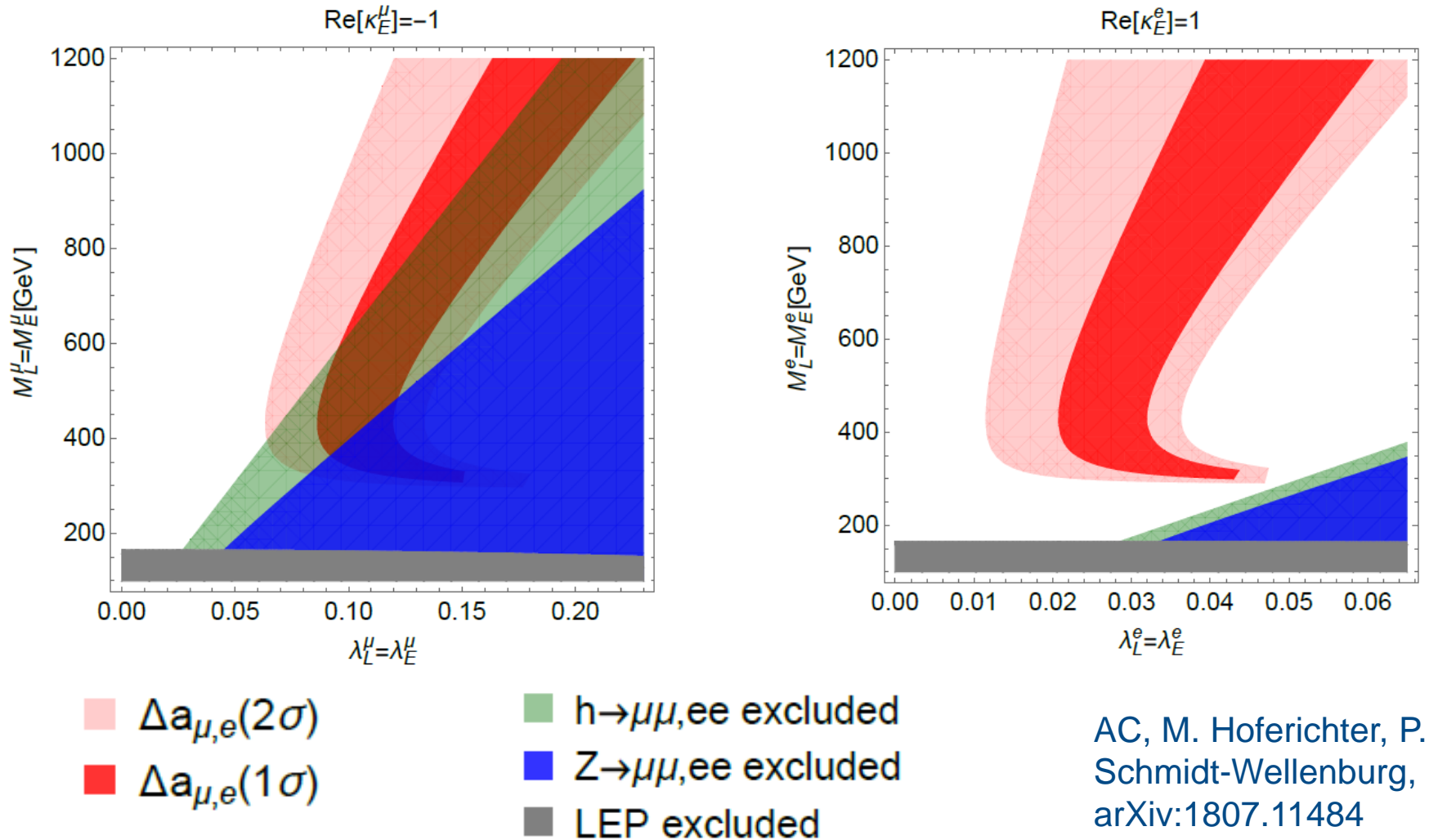

Works for a_e but tension with a_μ

Hadronic Vacuum Polarization

- New BMWc lattice QCD result

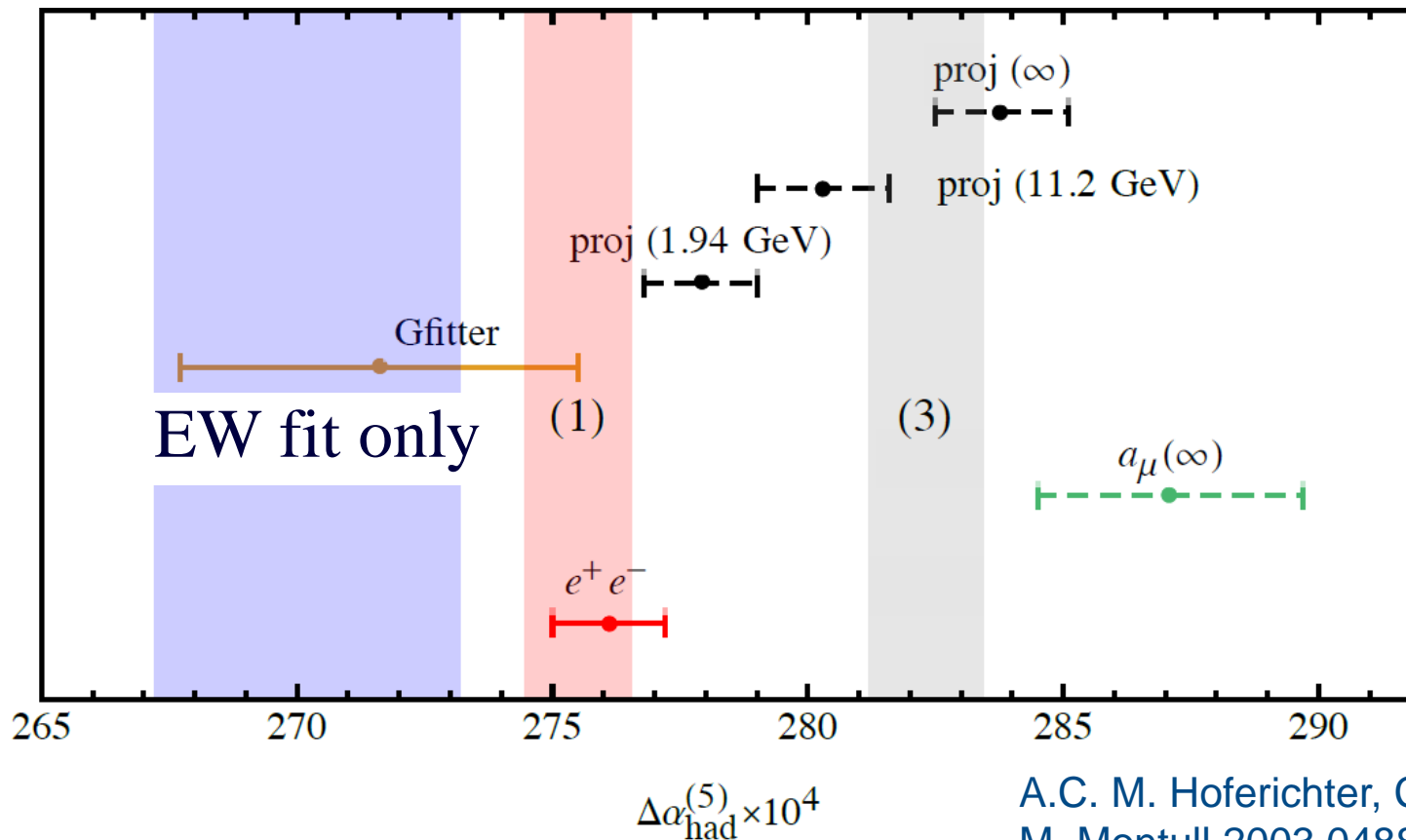

Up to 4σ tension in EW fit

$b \rightarrow c \tau \nu$ Global Fit

- Pure scalar-tensor explanations in tension with the B_c lifetime
- Pure left-handed vector, i.e. contribution to the SM operator gives good fit

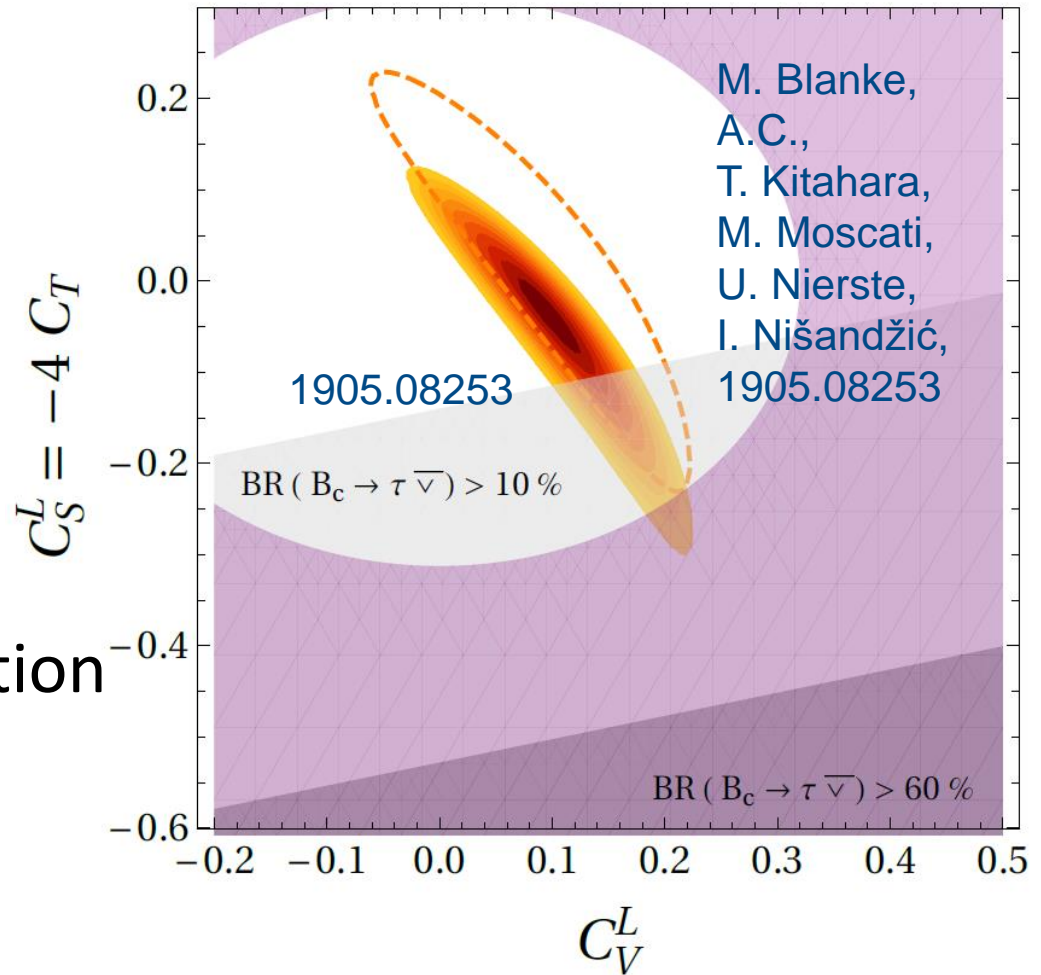

Global fit give up to 4σ preference for NP

Scalar Leptoquarks

Two Scalar Leptoquarks

AC, D. Mueller, T. Ota

arxiv:1703.09226

- Φ_1 scalar leptoquark singlet with $Y=-2/3$
- Φ_3 scalar leptoquark triplet with $Y=-2/3$

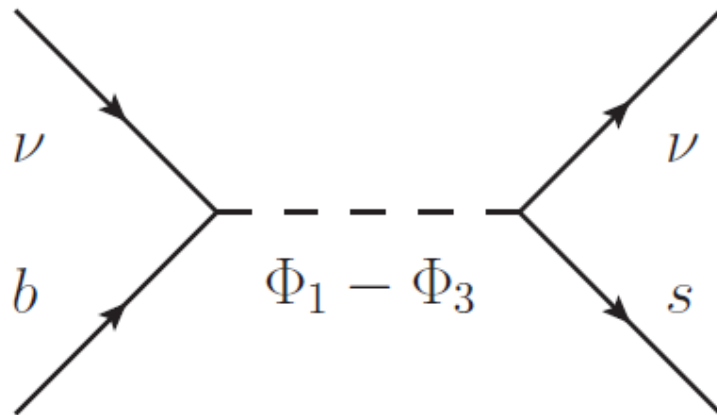
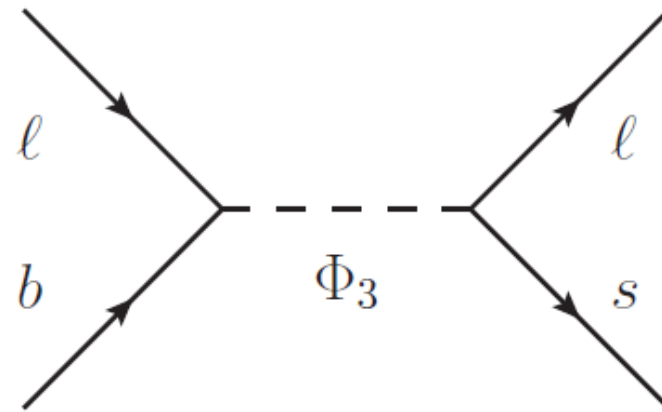
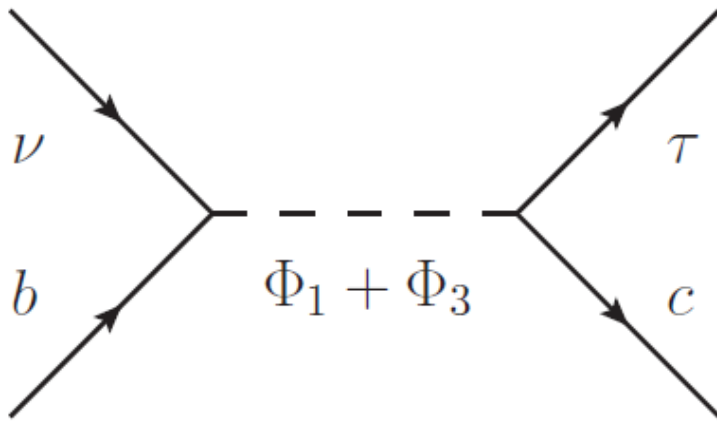

Constructive in $R(D^{(*)})$

Destructive in $b \rightarrow s \mu \mu$

R(D^(*)), b→sll and a_μ

■ 4 benchmark points

AC, D. Mueller, F. Saturnino
arxiv:1912.04224

	κ_{22}	κ_{32}	κ_{23}	κ_{33}	λ_{22}	λ_{32}	λ_{23}	λ_{33}	$\hat{\lambda}_{32}$	$\hat{\lambda}_{23}$
● p_1	-0.019	-0.059	0.58	-0.11	-0.0082	-0.016	-1.46	-0.064	-0.19	1.34
● p_2	-0.017	-0.070	-1.23	0.066	0.0078	-0.055	1.36	0.052	-0.053	-1.47
● p_3	0.0080	0.081	1.18	-0.073	-0.0017	0.16	-0.76	-0.068	0.023	1.23
● p_4	-0.0032	-0.21	0.44	-0.20	0.014	-0.10	-1.38	-0.068	-0.032	0.57
	$C_9^{\mu\mu} = -C_{10}^{\mu\mu}$	$C_9^{\ell\ell}$	$\frac{R(D)}{R(D)_{SM}}$	$\frac{R(D^*)}{R(D^*)_{SM}}$	$\frac{B_s \rightarrow \tau\tau}{B_s \rightarrow \tau\tau _{SM}}$	$\tau \rightarrow \mu\gamma$ $\times 10^8$	δa_μ $\times 10^{11}$	$V_{cb}^e/V_{cb}^\mu - 1$ $\times 10^6$	$Z \rightarrow \tau\mu$ $\times 10^{10}$	
● p_1	-0.52	-0.21	1.15	1.10	59.88	4.35	207	291	0.117	
● p_2	-0.56	-0.28	1.14	1.10	99.76	0.766	199	448	2.38	
● p_3	-0.31	-0.31	1.14	1.09	112.5	3.62	255	17	0.129	
● p_4	-0.31	-0.31	1.13	1.11	112.5	0.734	230	934	45.6	
	$C_{SL}^{\tau\tau} = -4C_{TL}^{\tau\tau}$	$C_{VL}^{\tau\tau}$	$R_{\nu\nu}^{K(*)}$	$\frac{\Delta m_{B_s}^{NP}}{\Delta m_{B_s}^{SM}}$	$B \rightarrow K\tau\mu$ $\times 10^5$	$\tau \rightarrow \phi\mu$ $\times 10^8$	$\tau \rightarrow \mu ee$ $\times 10^{11}$	$ \Lambda_{33}^{LQ}(0) $ $\times 10^5$	$\frac{\Delta_{33}^L(m_Z^2)}{\Lambda_{SM}^{LL} \times 10^{-5}}$	
● p_1	0.023	0.040	2.33	0.1	0.512	1.27	44.94	1.11	-3.64	
● p_2	0.020	0.040	0.87	0.16	3.32	4.73	7.783	0.90	-3.02	
● p_3	0.023	0.037	1.08	0.19	4.07	1.00	37.89	0.89	-3.51	
● p_4	0.010	0.047	2.43	0.18	3.69	0.0021	18.60	3.12	-10.04	

Common explanation possible

Important Loop-Effects

- Explanation of $b \rightarrow c\tau\nu$ requires large $b\tau$ and $s\tau$ couplings (follows from $SU(2)$ invariance)

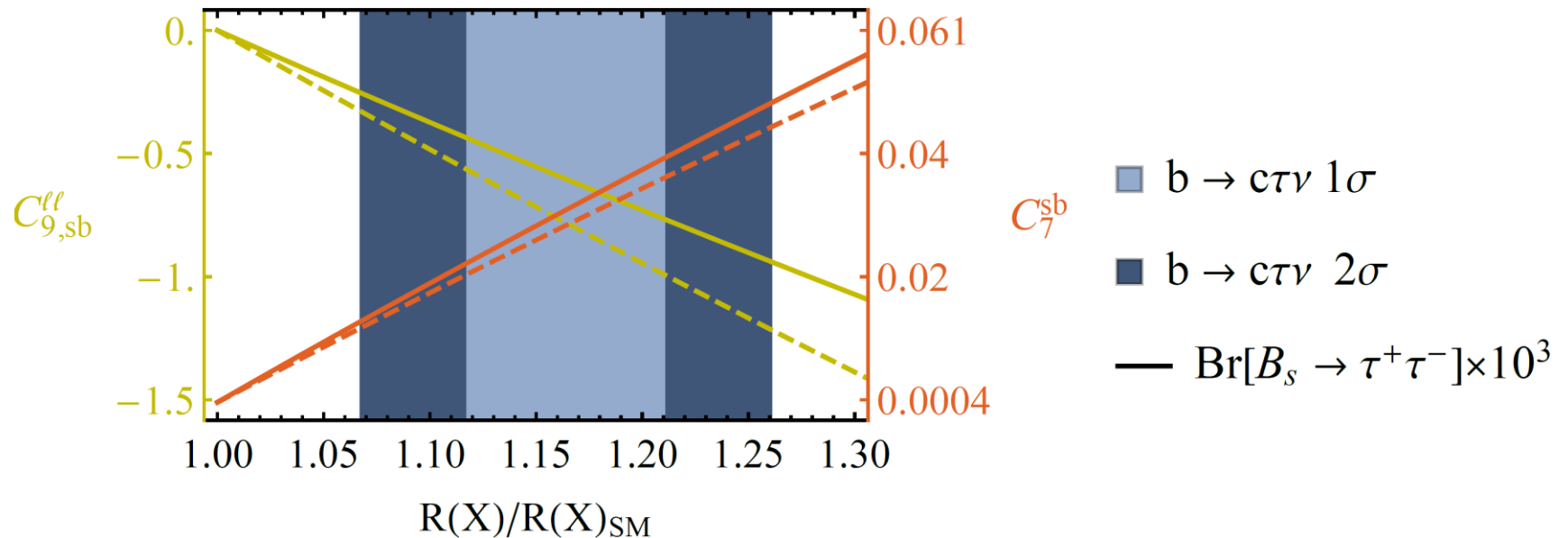

AC, C. Greub, D. Müller,
F. Saturnino, PRL 2018

Large loop effects in $b \rightarrow s\mu\mu$

$R(D^{(*)})$ and $b \rightarrow s\tau\tau$

- Large couplings to the second generation

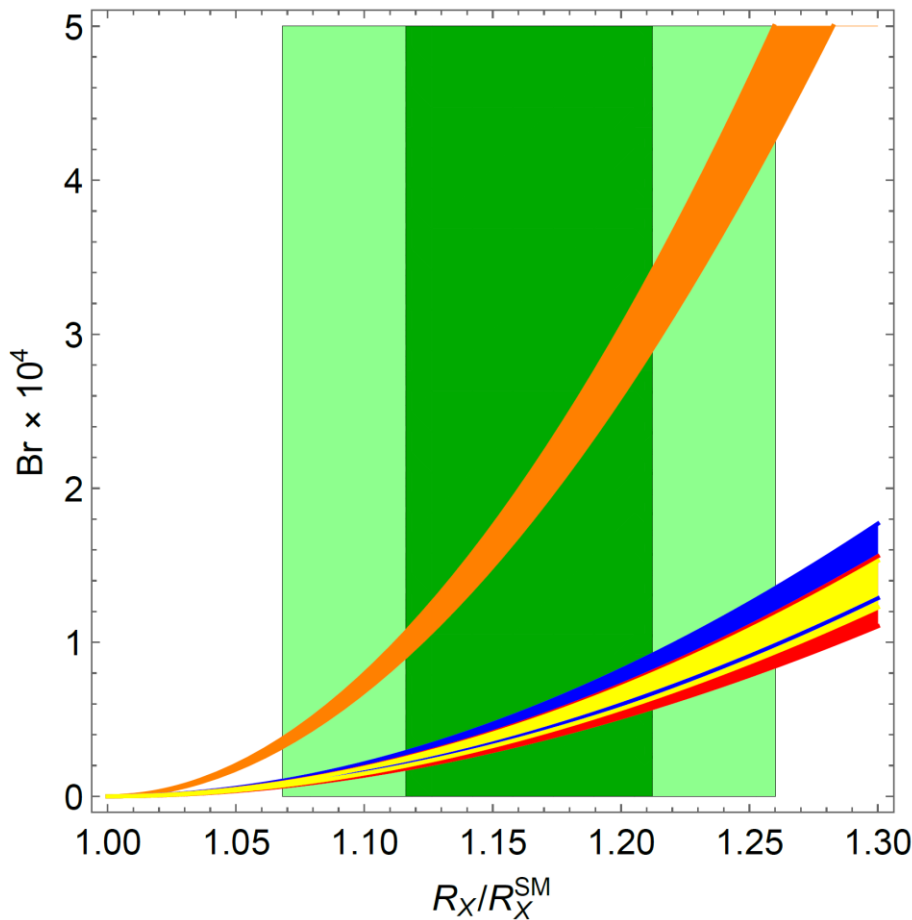

- $R_{D^{(*)}} \& R_{J/\psi} 2\sigma$
- $R_{D^{(*)}} \& R_{J/\psi} 1\sigma$
- $Br[B_S \rightarrow \tau\tau]$
- $Br[B \rightarrow K^* \tau\tau]$
- $Br[B \rightarrow K \tau\tau]$
- $Br[B_S \rightarrow \phi \tau\tau]$

$b \rightarrow s\tau\tau$
very
strongly
enhanced

B. Capdevila, AC, S. Descotes-Genon, L. Hofer and J. Matias, PRL.120.181802

Important Loop-Effects

- Explanation of $b \rightarrow c\tau\nu$ requires large LQ- $b\tau$ and LQ- $c-v_\tau$ couplings
- Via SU(2) invariance this leads to large effects in $b \rightarrow s\tau\tau$ processes
- Closing the tau-loop gives a LFU effect in $b \rightarrow sll$
- Effect goes in the right direction

M. Algueró, B. Capdevila, S. Descotes-Genon, P. Masjuan, J. Matias, PRD, 2019

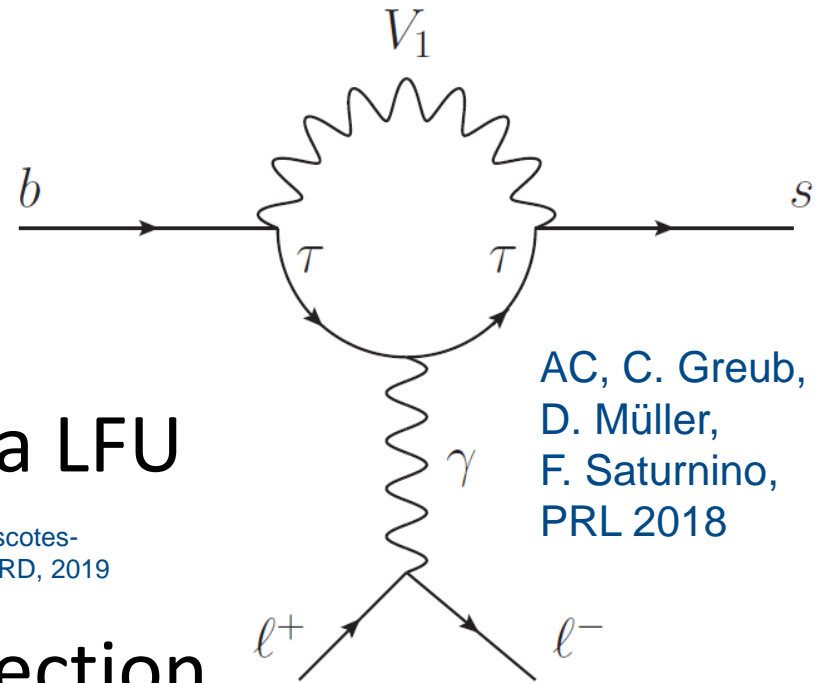

AC, C. Greub,
D. Müller,
F. Saturnino,
PRL 2018

Explanation of $b \rightarrow c\tau\nu$ leads to
loop effects in $b \rightarrow s\mu\mu$

Vector LQ Phenomenology

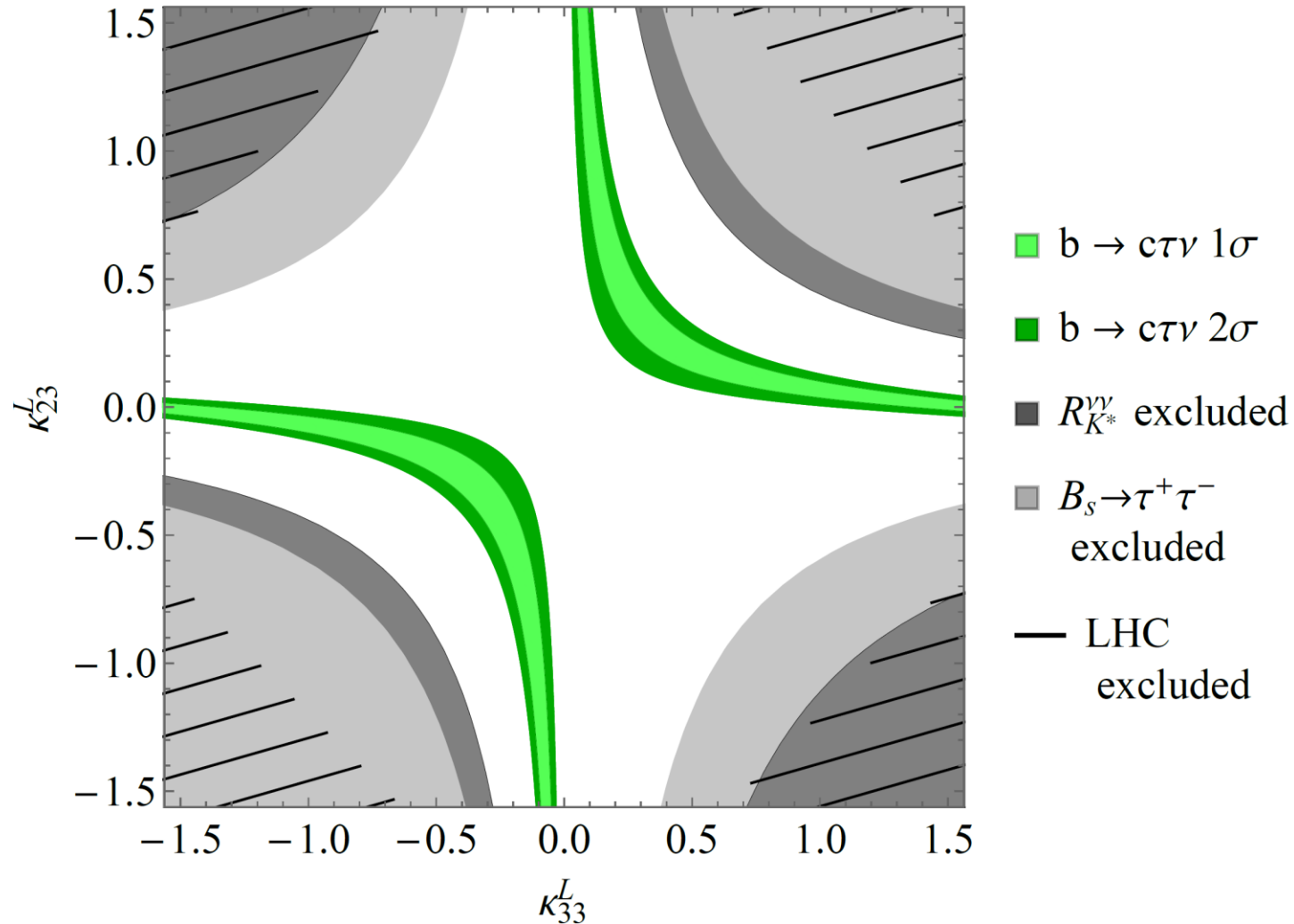

Compatible with constraints for generic couplings

Possible UV completions

- $SU(4) \times SU(3)' \times SU(2)_L \times U(1)_Y$ + Vector-like fermions
L. Di Luzio, A. Greljo, M. Nardecchia, arXiv:1708.08450
- $SU(4) \times U(2)_L \times SU(2)_R$ + Vector-like fermions
L. Calibbi, AC, T. Li, arXiv:1709.00692
- $SU(4) \times SU(4) \times SU(4)$
M. Bordone, C. Cornella, J. Fuentes-Martin, G. Isidori, arXiv:1712.01368
- $SU(4) \times SU(2)_L \times SU(2)_R$ including scalar LQs and light right-handed neutrinos
J. Heeck, D. Teresi, arXiv:1808.07492
- $SU(8)$ might even explain ε'/ε
S. Matsuzaki, K. Nishiwaki and K. Yamamoto, arXiv:1806.02312
- $SU(4) \times SU(2)_L \times SU(2)_R$ in RS background
M. Blanke, AC, arXiv:1801.07256

Good solution, but challenging UV completion

Pati-Salam RS Phenomenology

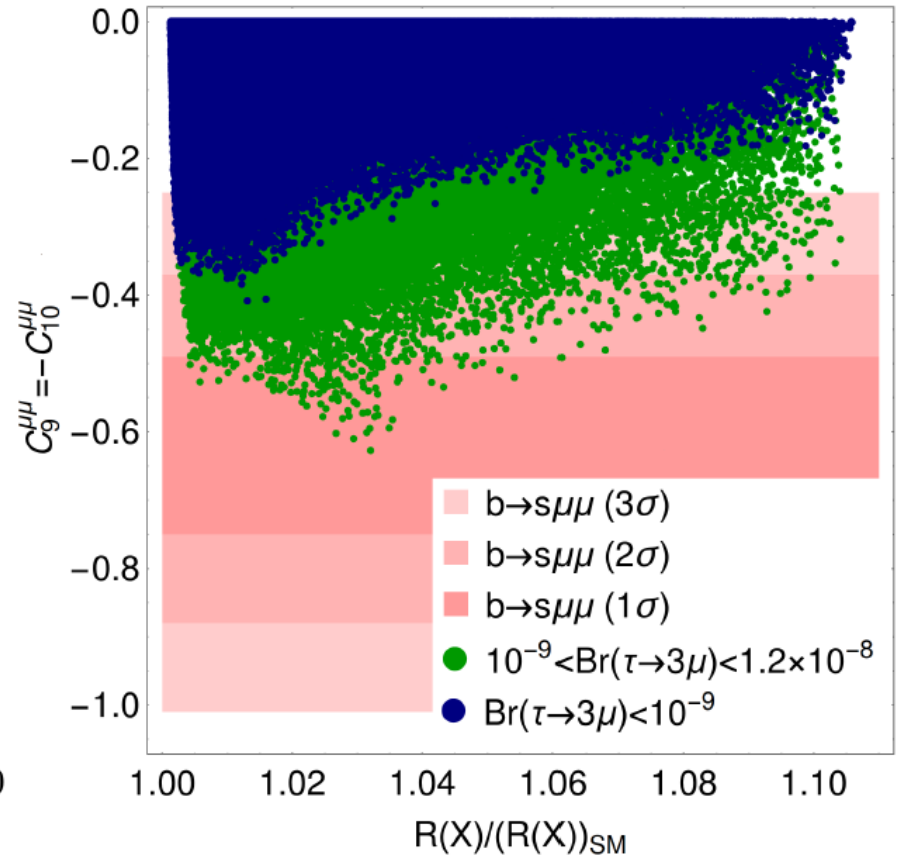
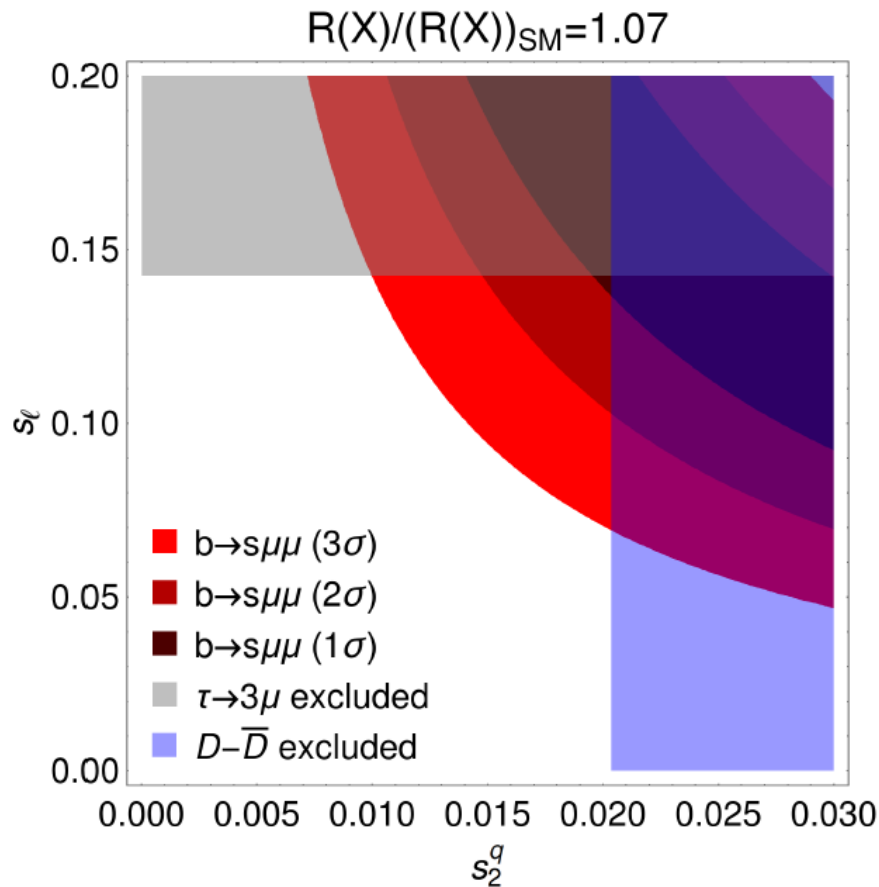

$$M = 3 \text{ TeV}, s_2^\ell = 0.2, s_3^\ell = 1/\sqrt{2} \text{ and } s_3^q = \sqrt{3}/2$$

M. Blanke, AC, PRL 2018

Model well motivated + limited but sizable effect

$\tau \rightarrow \mu \nu \bar{\nu}$

- Ratios of leptonic tau decays

$$\frac{\mathcal{A}_{\text{EXP}}(\tau \rightarrow \mu \nu \bar{\nu})}{\mathcal{A}_{\text{SM}}(\mu \rightarrow e \nu \bar{\nu})} = 1.0029 \pm 0.0014$$

$$\frac{\mathcal{A}_{\text{EXP}}(\tau \rightarrow \mu \nu \bar{\nu})}{\mathcal{A}_{\text{SM}}(\tau \rightarrow e \nu \bar{\nu})} = 1.0018 \pm 0.0014$$

$$\frac{\mathcal{A}_{\text{EXP}}(\tau \rightarrow e \nu \bar{\nu})}{\mathcal{A}_{\text{SM}}(\mu \rightarrow e \nu \bar{\nu})} = 1.0010 \pm 0.0014$$

$$\rho = \begin{pmatrix} 1.00 & 0.49 & 0.51 \\ 0.49 & 1.00 & -0.49 \\ 0.51 & -0.49 & 1.00 \end{pmatrix}$$

- NP in muon decay too constrained from EW data

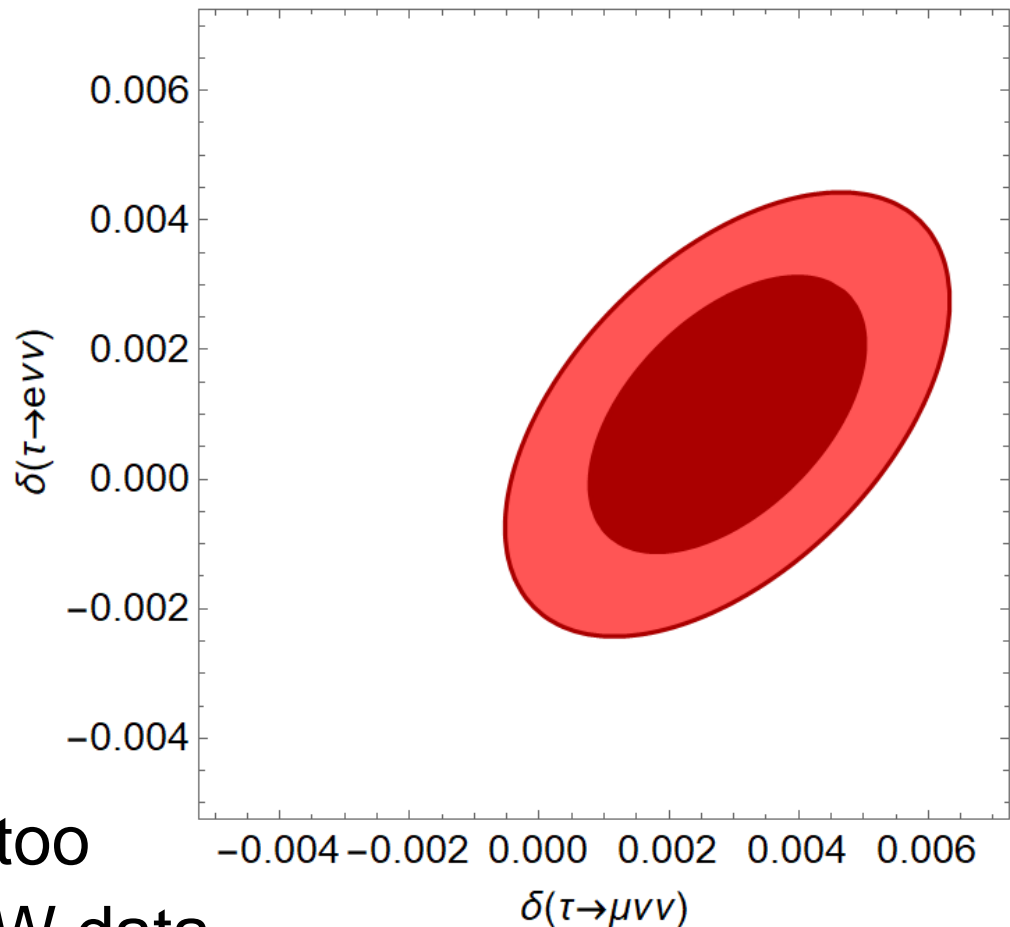

$\approx 2\sigma$ hint for LFUV in tau decays

$\tau \rightarrow \mu \nu \nu$

- L_μ - L_τ Z' (box diagrams)
- LFV violating Z'
- Modified $W\nu$ couplings
- W'
- Singly charged scalar

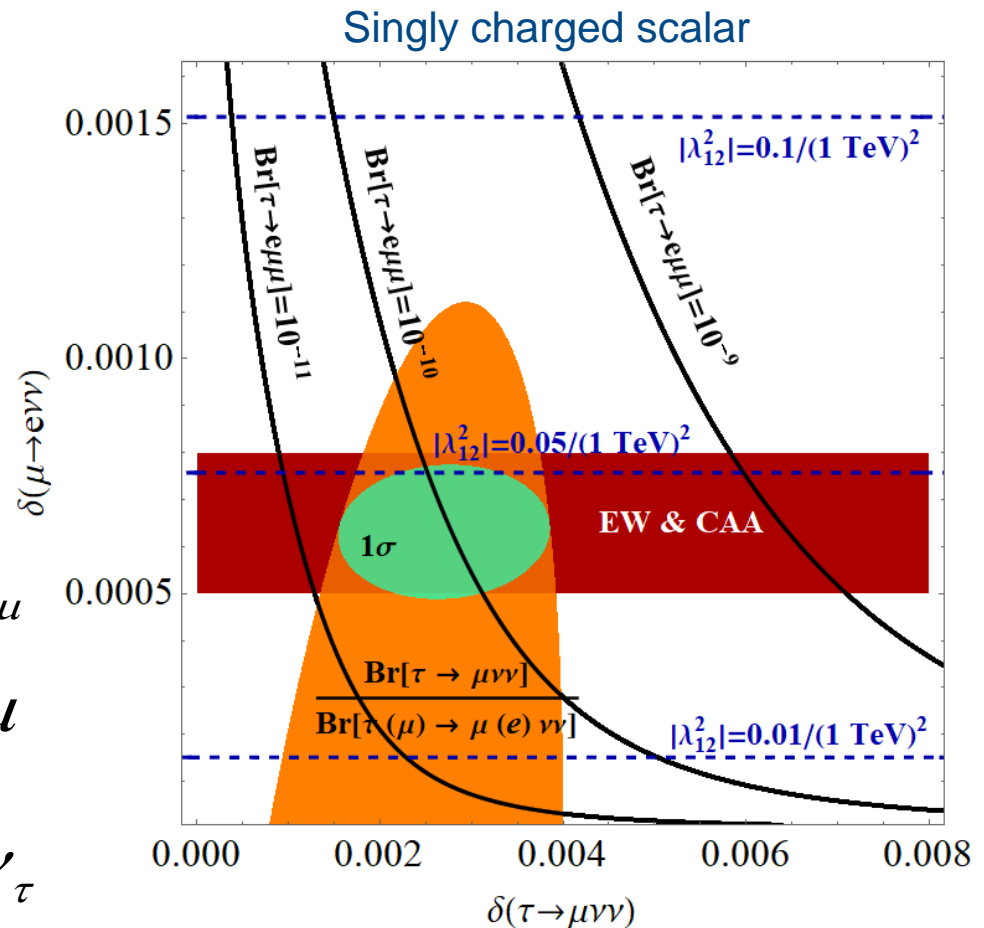
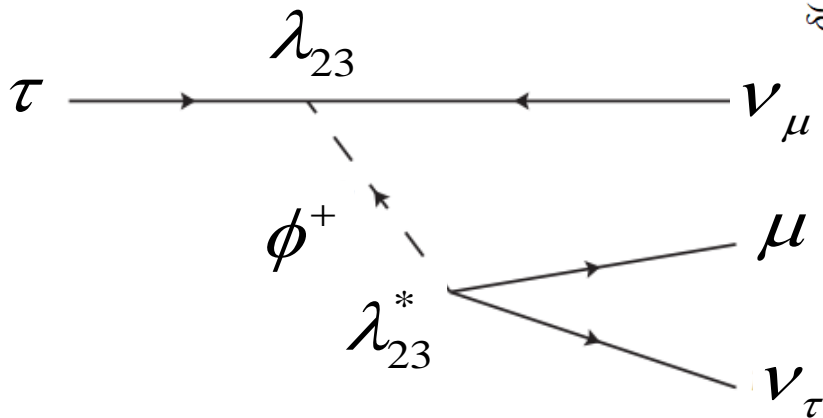

A.C., F. Kirk, C. Manzari, L. Panizzi, arXiv:2012.09845

4 σ hint for modified neutrino couplings

W' Explanation of CAA

- W' effects in LFU and EW observables
- Z' effects in LHC di-jet and di-lepton tail searches

▨ QWEAK (excluded 68% CL)
 ▨ LHC-dilepton (excluded 95% CL)
 ■ EW+LFU (68% CL)
 ■ All data (68% CL)

▨ LHC-dilepton (excluded 95% CL)
 ▨ LHC-jet + E_T^{miss} (excluded 95% CL)
 ■ EW+LFU (95% CL)
 ■ All data (95% CL)

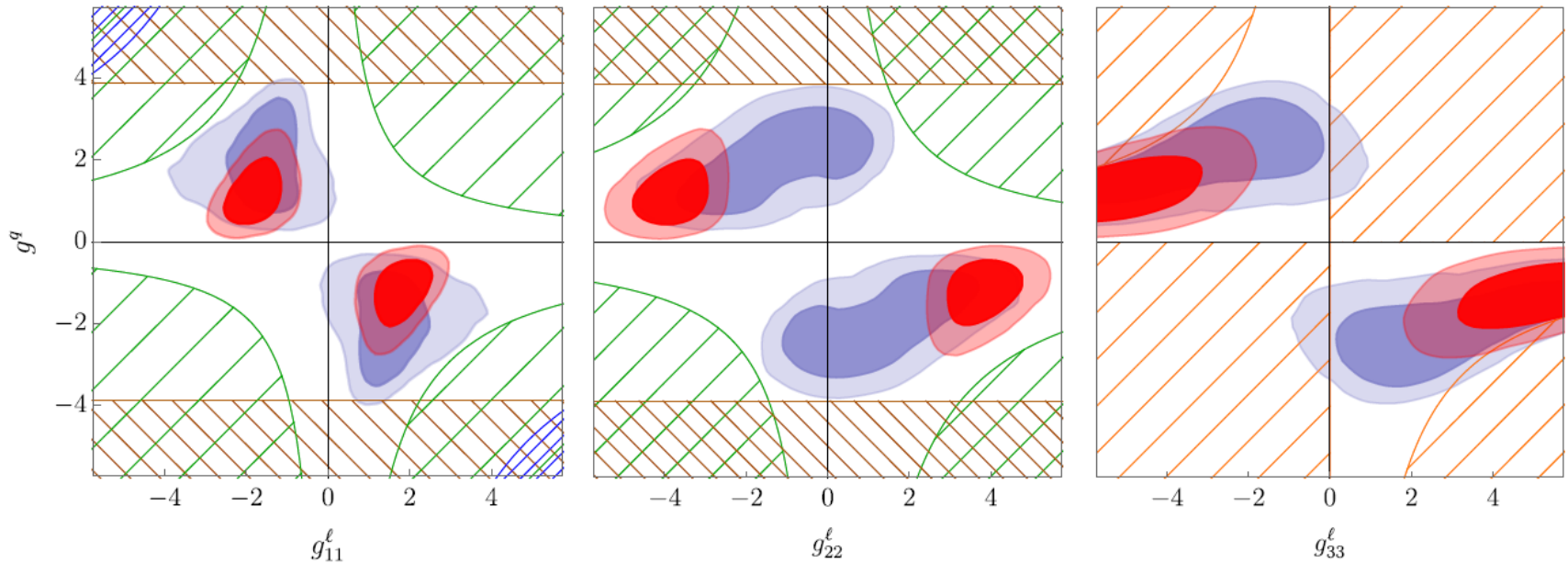

$R(V_{us})$ can be explained by a left-handed W'

Vector Triplet in $R(V_{us})$ & $b \rightarrow sll$

- Region preferred by EW fit overlaps with $b \rightarrow sll$ region
- Correlations between e.g. $\pi \rightarrow \mu\nu/\pi \rightarrow e\nu$ and $R(K^{(*)})$ are predicted
- Global fit significantly improved

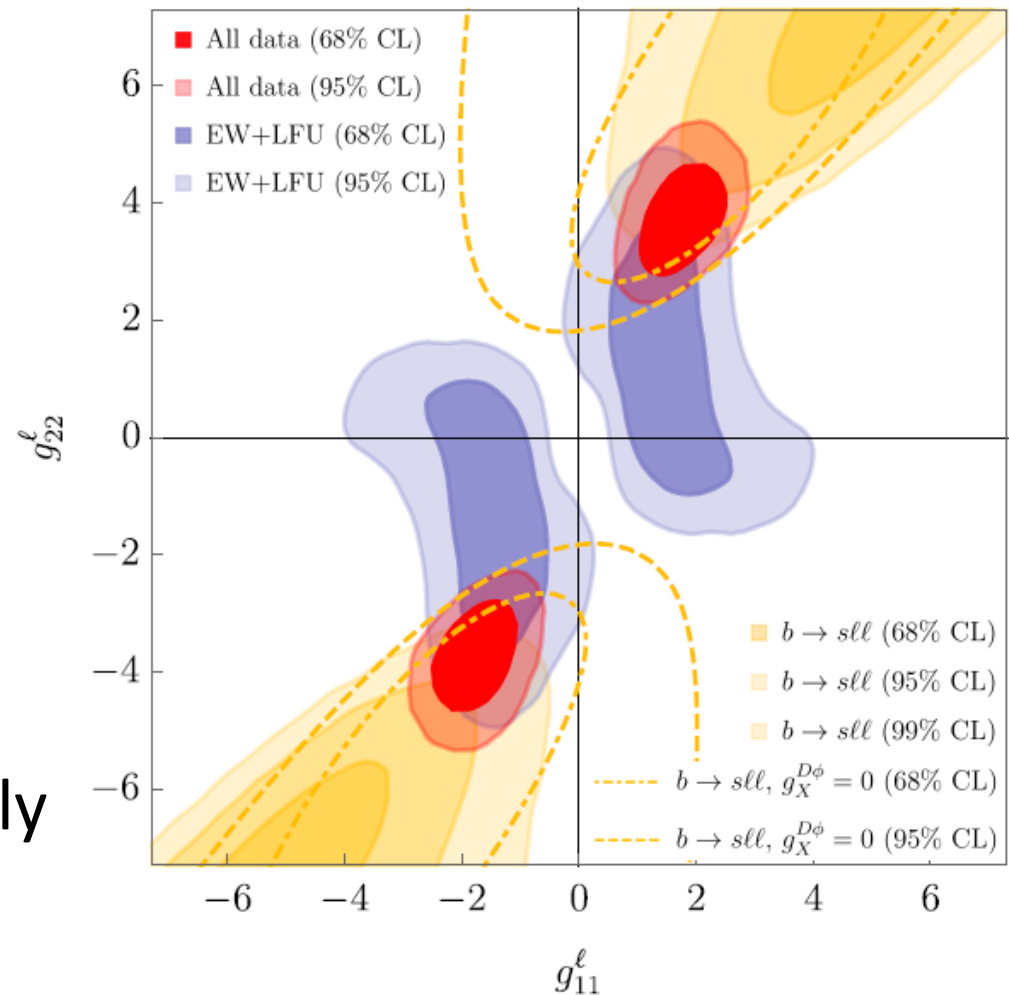

Common explanation possible

a_μ vs $Z \rightarrow \mu\mu$

■ Chirally enhanced effects via top-loops

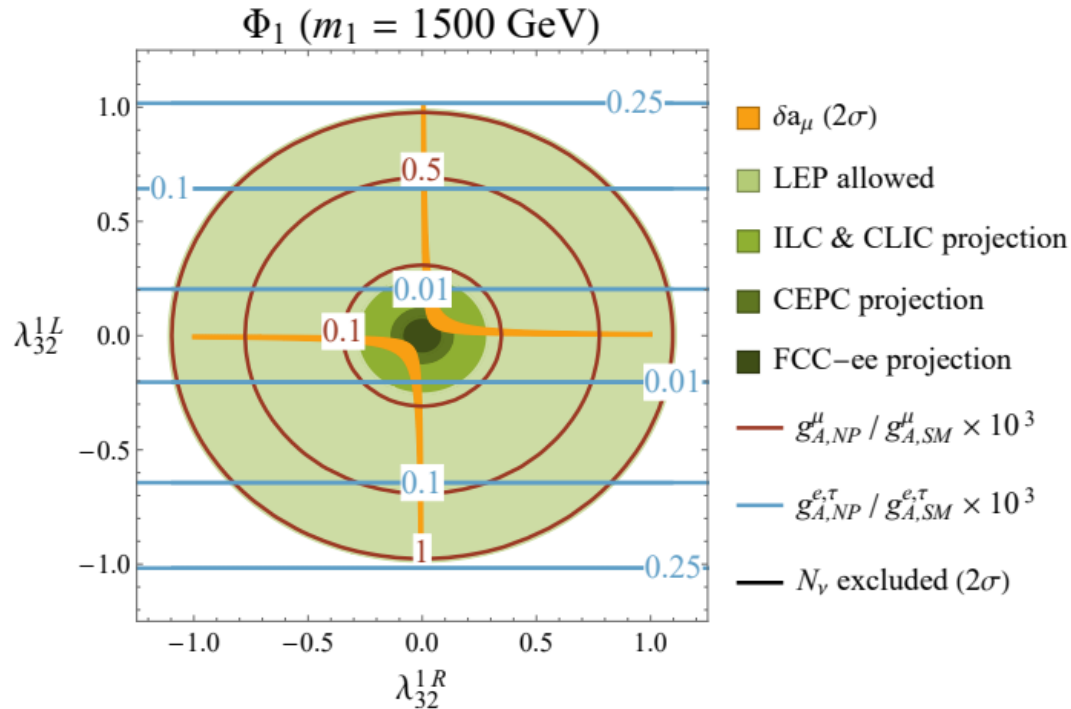

$\lambda_\mu^{L,R}$

Left-, right-handed
muon-top coupling

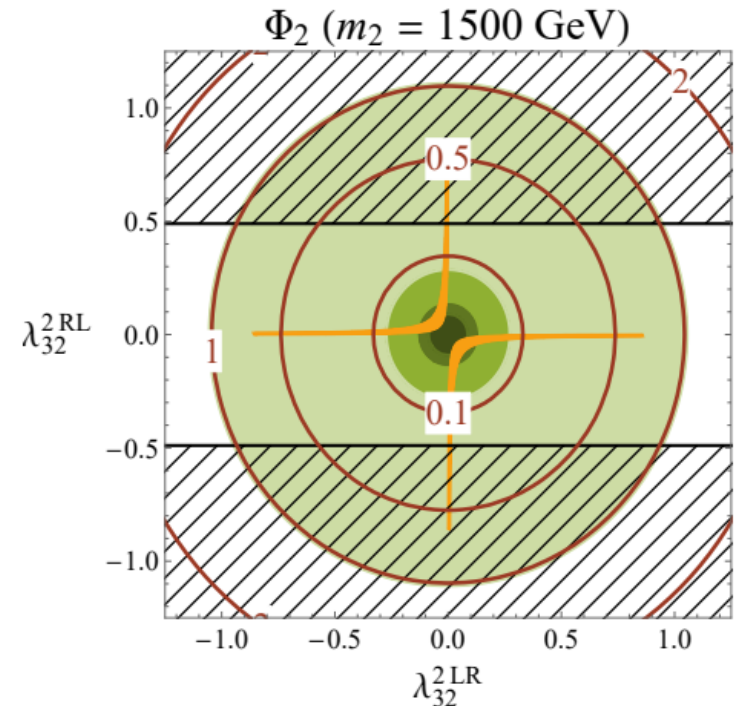

E. Leskow, A.C., G. D'Ambrosio,
D. Müller 1612.06858
A.C, C. Greub, D. Müller, F.Saturnino,
2010.06593

$Z \rightarrow \mu\mu$ at future colliders

Global Fit to the CKM Matrix

- Tree-level determinations of CKM elements (with light leptons) agree with $\Delta F=2$ processes
- Picture of CKM Flavour violation established, but sub leading NP possible

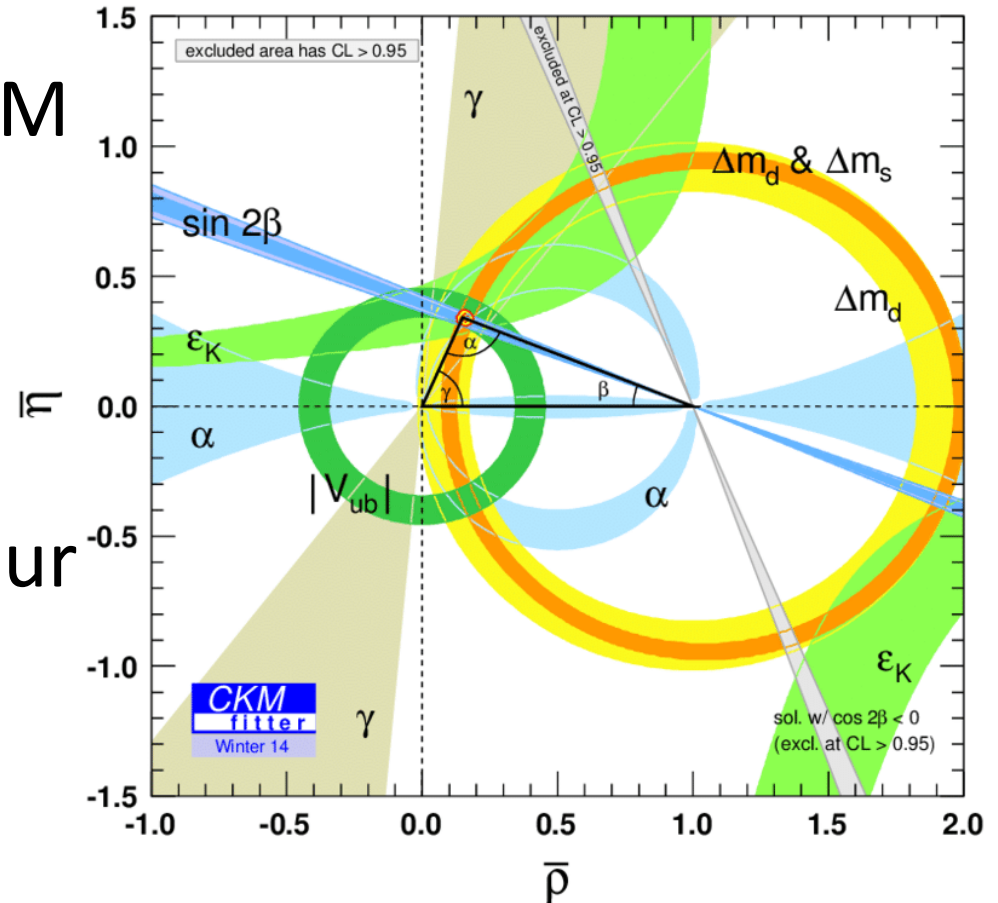

Still room for New Physics effects of $O(10\%)$