

I. Fast workshop on “Injectors for storage ring based light sources”

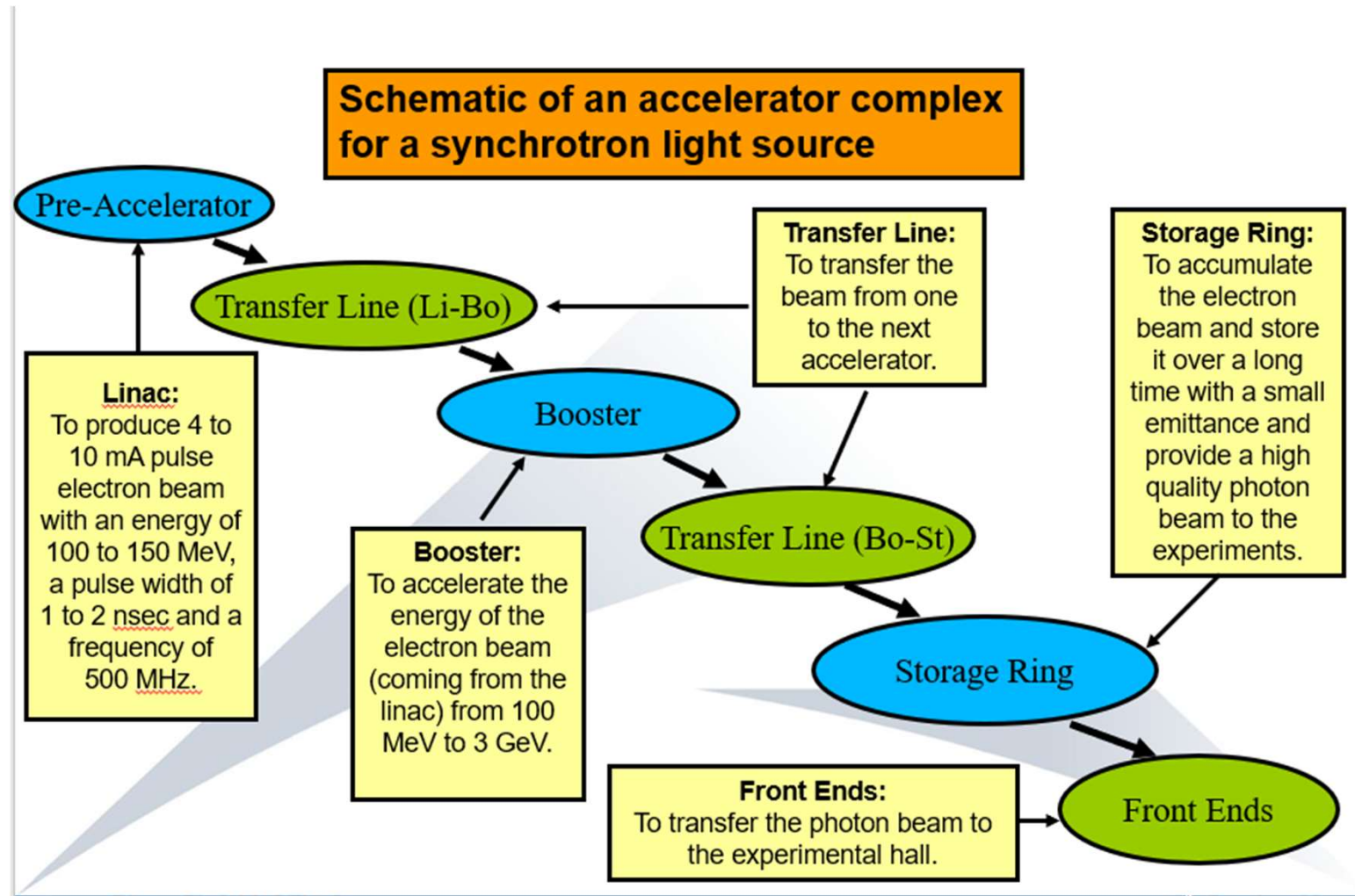
Overview of existing injectors

According to www.lightsources.org there are more than 50 light sources in the world (10 in Americas, 15 in Asia and Australia plus 20 in Europe and the Middle East).

Because it is not possible to present the injectors of all Light Sources, I made a selection of 10 sources:



I. Fast workshop on “Injectors for storage ring based light sources”



NSLS I – X-RAY and VUV-Source (1982)

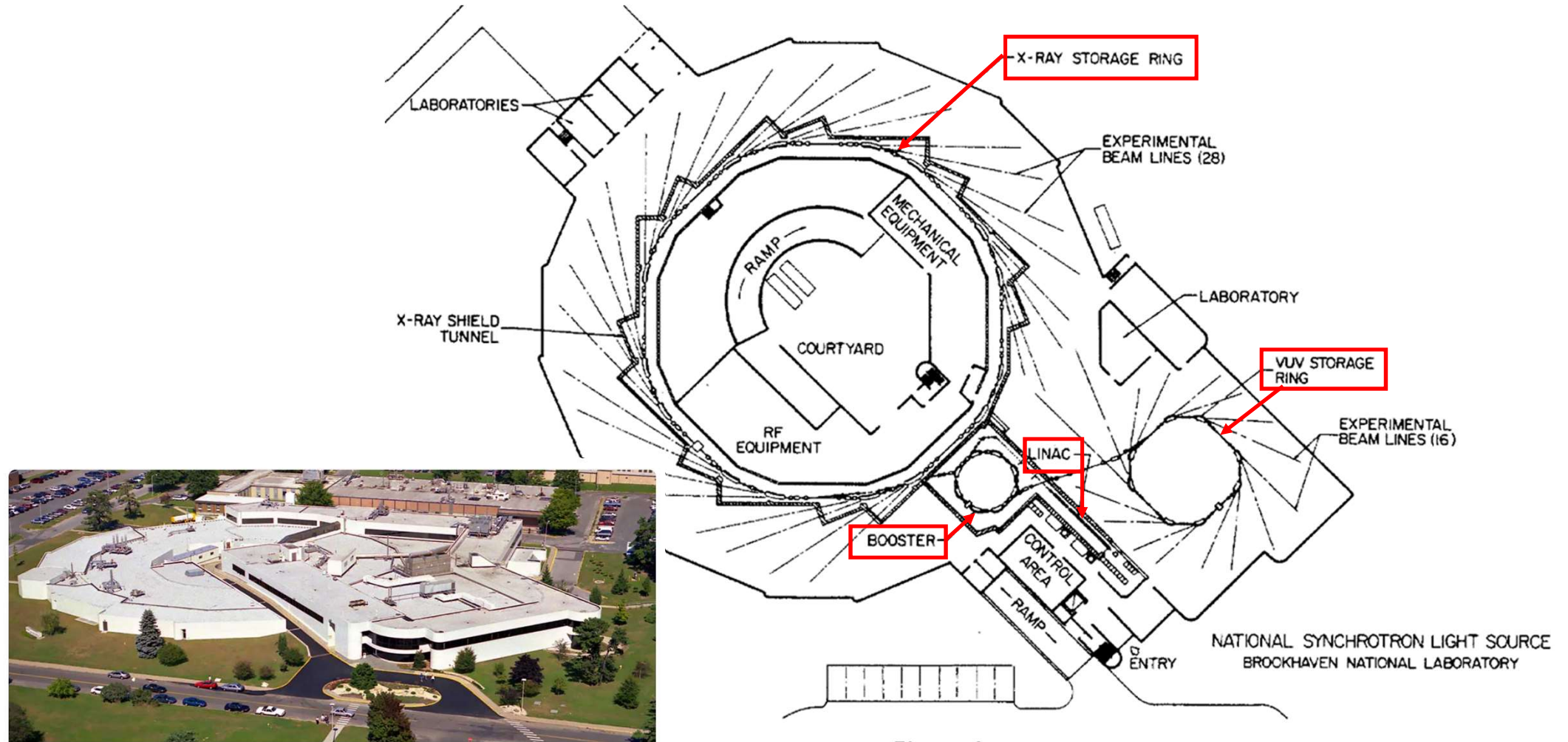
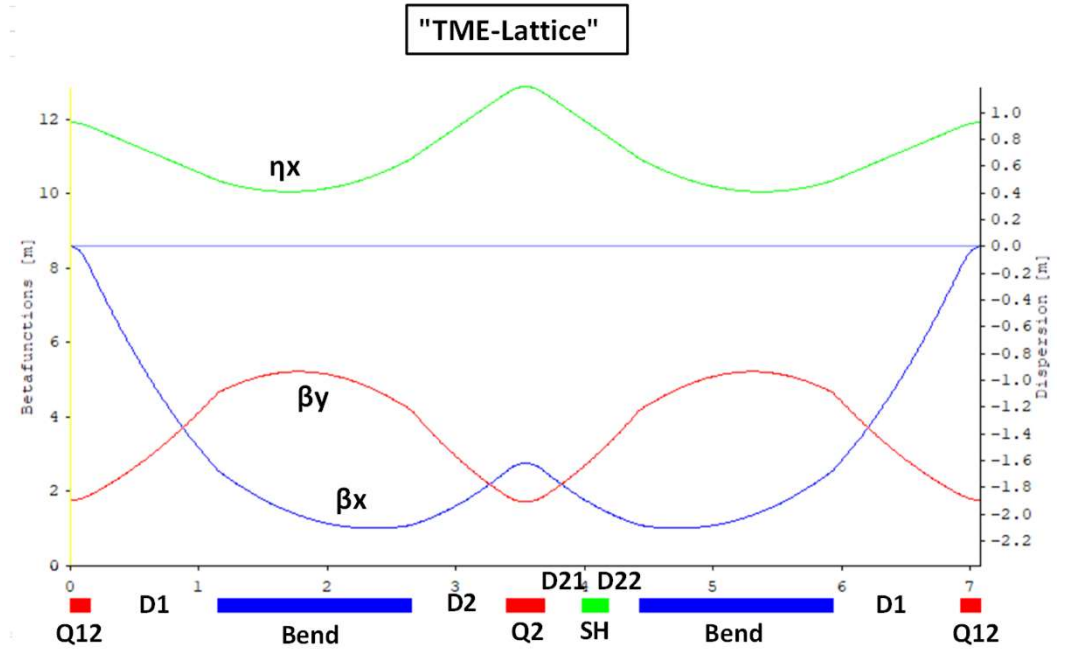
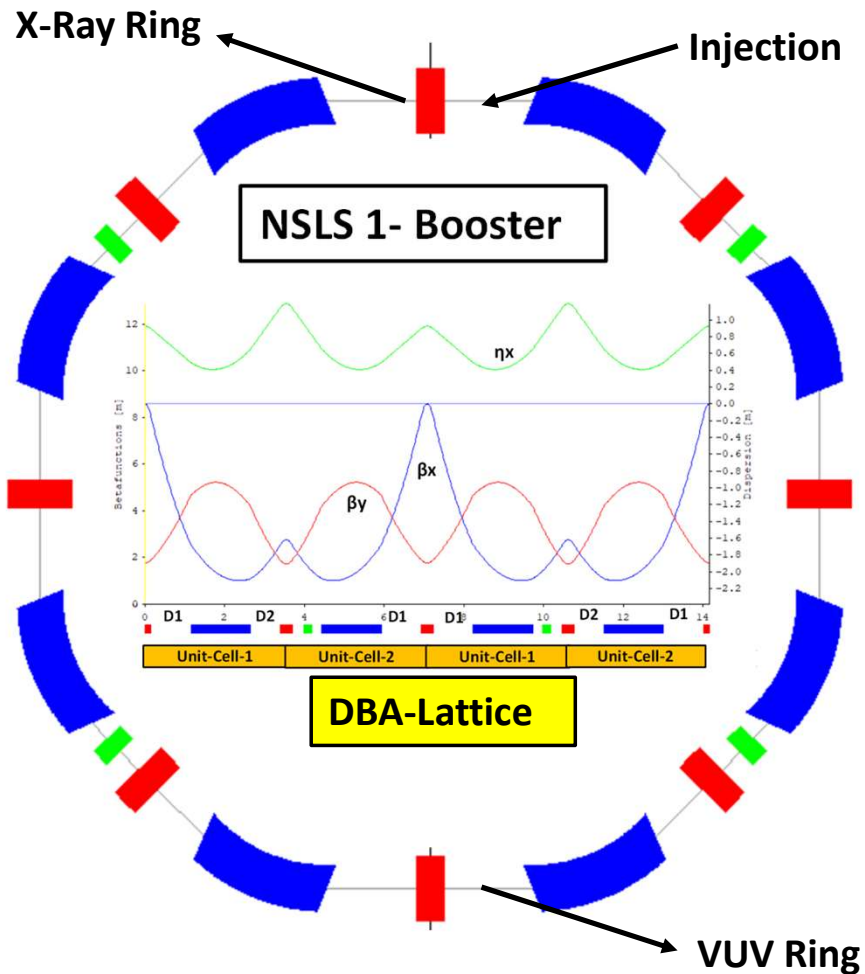


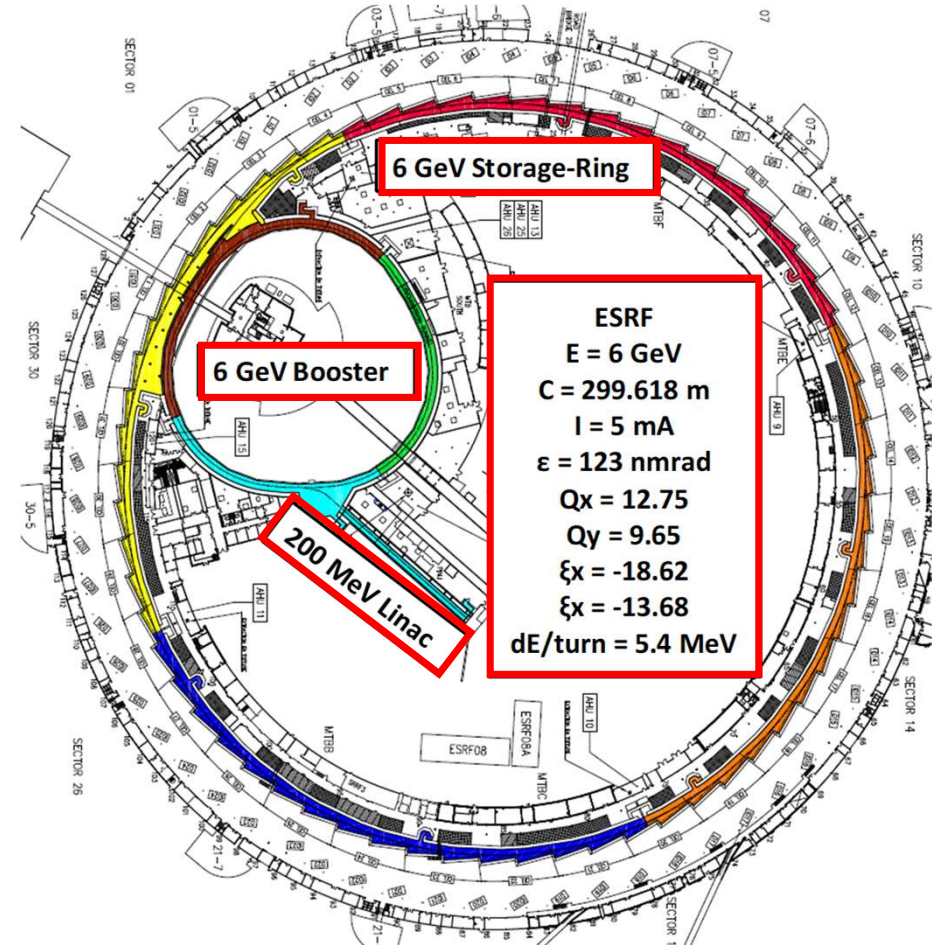
Figure 1.

NSLS I - Booster



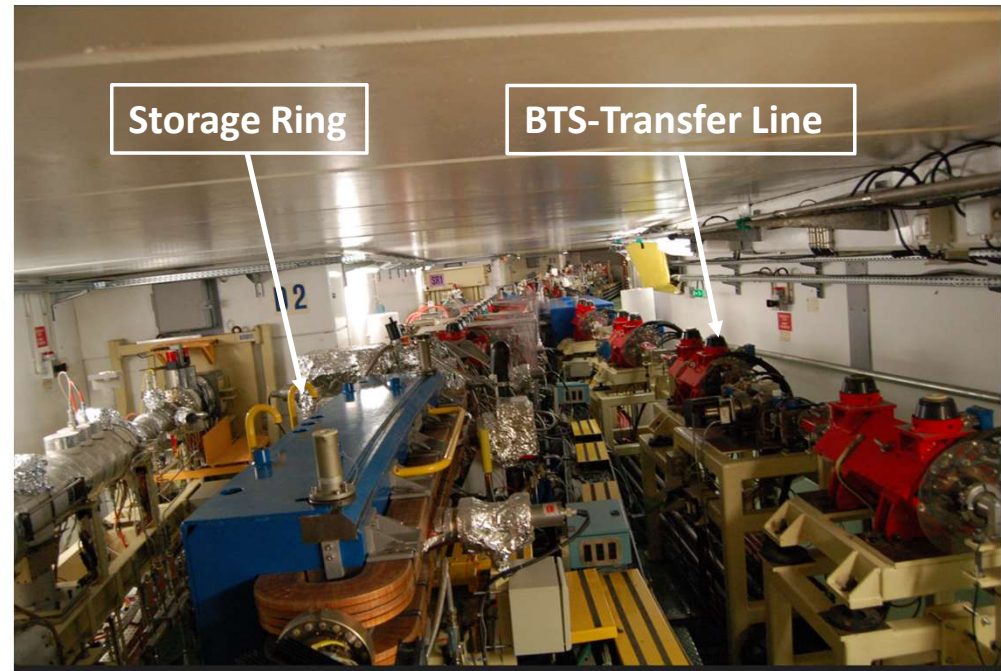
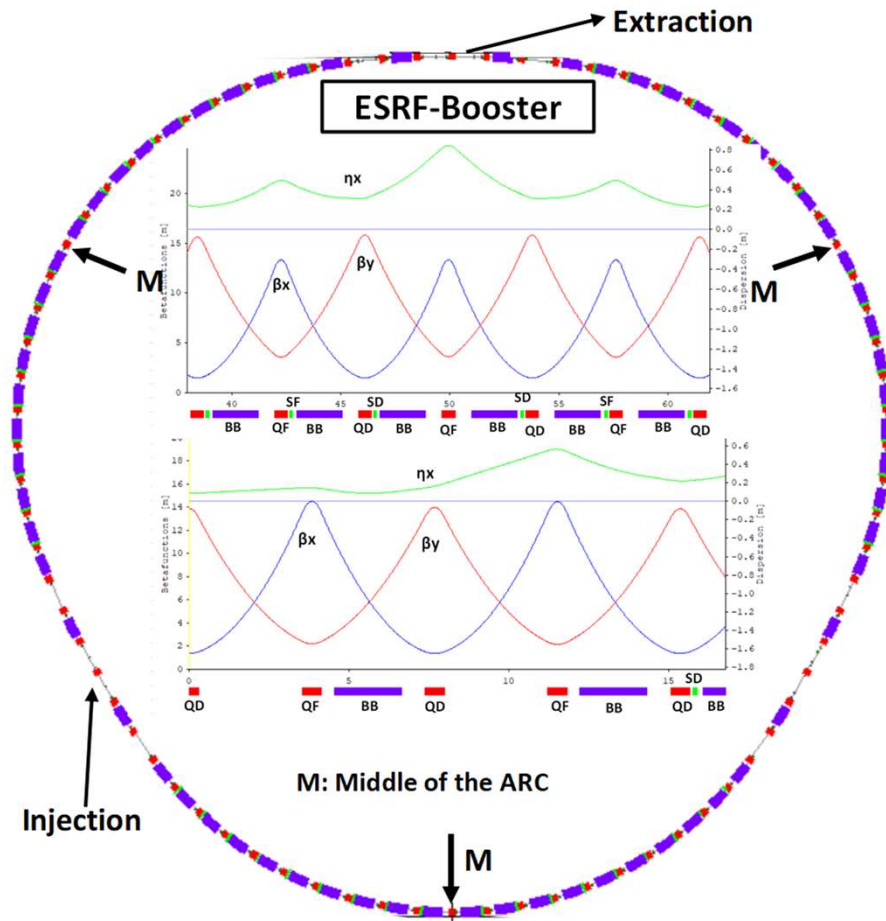
Bend: $L = 1.5 \text{ m}$, $\phi = 45^\circ$, $\rho = 1.91$, $\phi_1 = \phi_2 = 22.5^\circ$, $B = 1.222 \text{ T}$, $G = -0.744 \text{ T/m}$,
 $B'' = -11.7 \text{ T/m}^2$
 Q1: $L = 0.3 \text{ m}$, $G = 6.88 \text{ T/m}$, $Q_{12} = Q_1/2$, Q2 : $L = 0,3 \text{ m}$, $G = 8.74 \text{ T/m}$
 SH: $L = 0.2 \text{ m}$, $B'' = 105 \text{ T/m}^2$
 D1: $L = 1.0 \text{ m}$, D2: $L = 0.74 \text{ m}$, D21: $L = 0.29 \text{ m}$, D22: $L = 0.25 \text{ m}$

ESRF – Injector (1992)

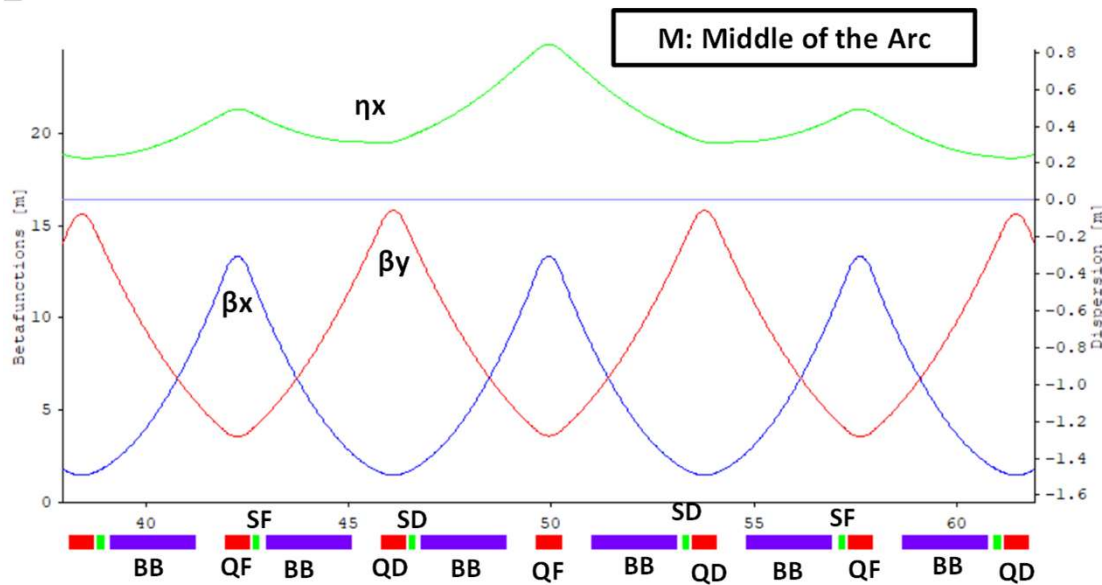


Thomas Perron

ESRF - Injector



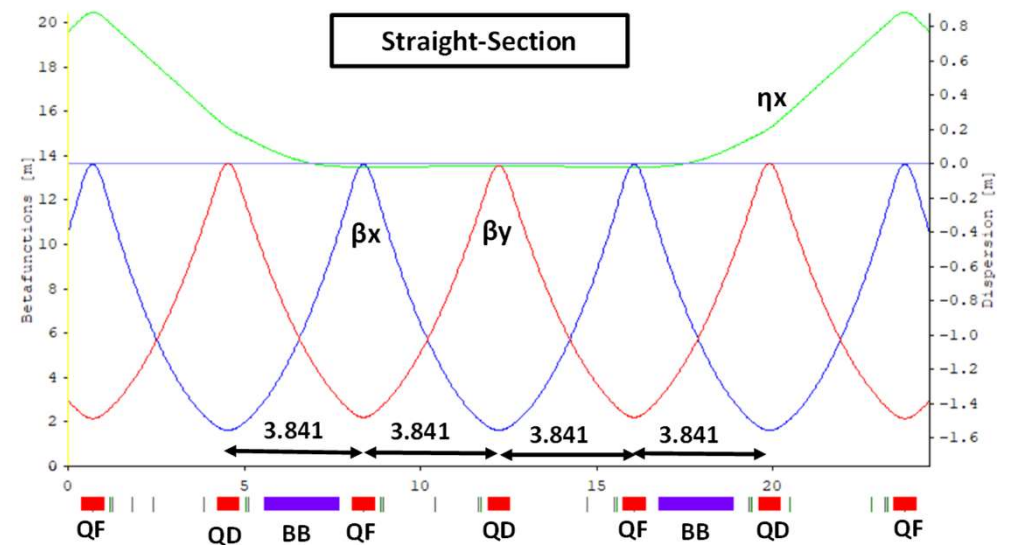
ESRF – Booster: Lattice



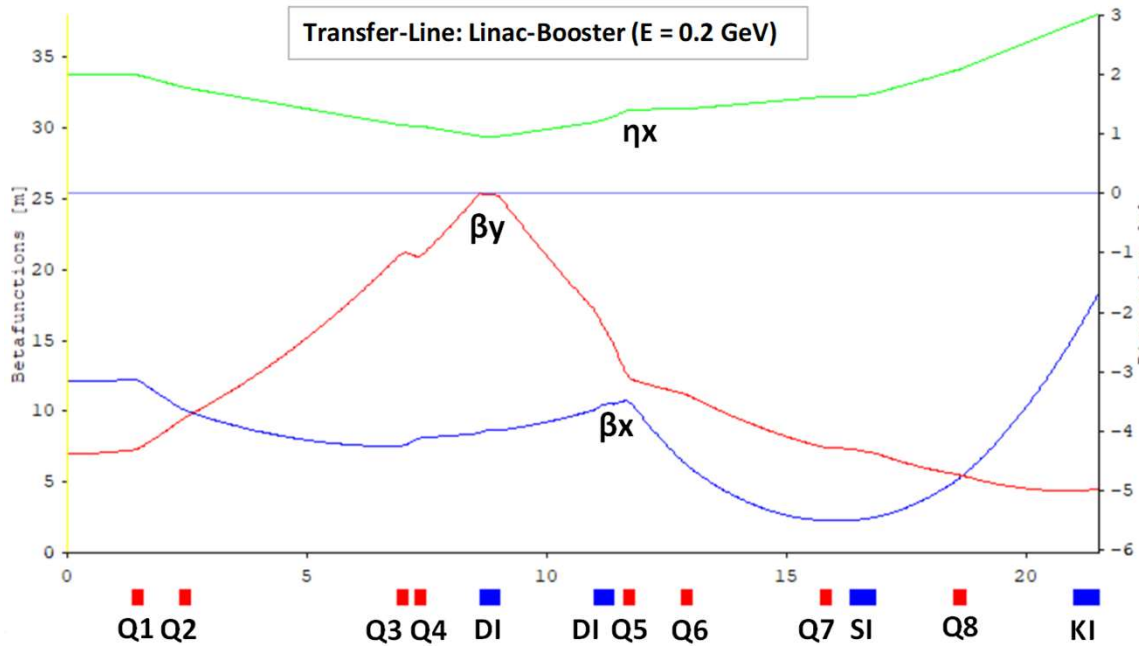
BB: $L = 2.094 \text{ m}$, $\phi = 5.4545^\circ$, $\rho = 22 \text{ m}$, $B = 0.91 \text{ T}$

QF: $L = 0.3 \text{ m}$, $G = 14.73 \text{ T/m}$, QD: $L = 0.3 \text{ m}$, $G = 13.21 \text{ T/m}$,

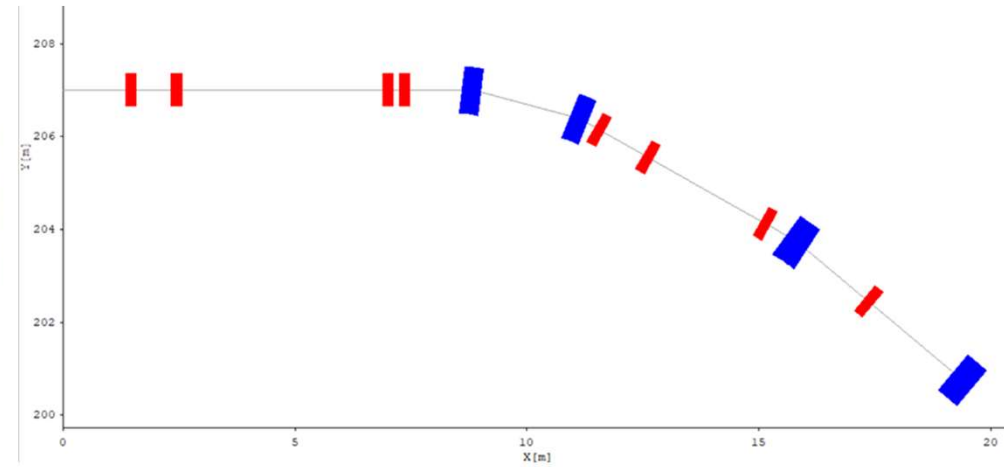
SF: $L = 0.14 \text{ m}$, $B'' = 218 \text{ T/m}^2$, SD: $L = 0.14 \text{ m}$, $G = 252 \text{ T/m}^2$,



ESRF – Booster: LTB-Transfer-Line

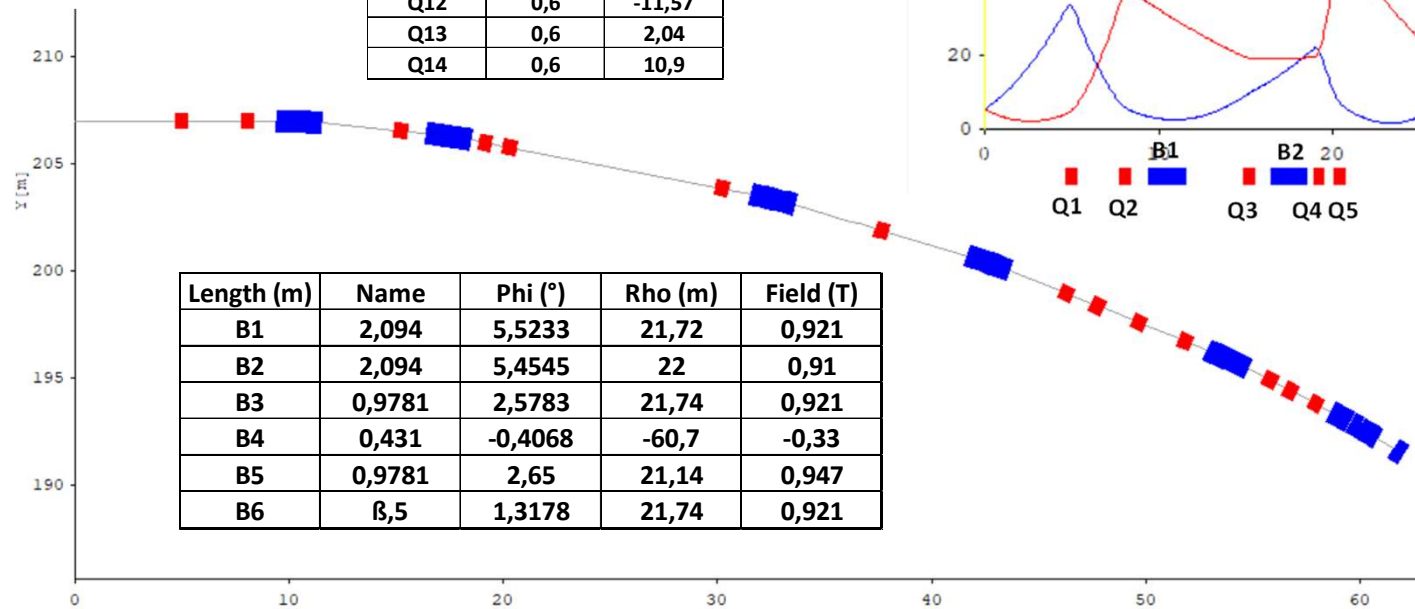
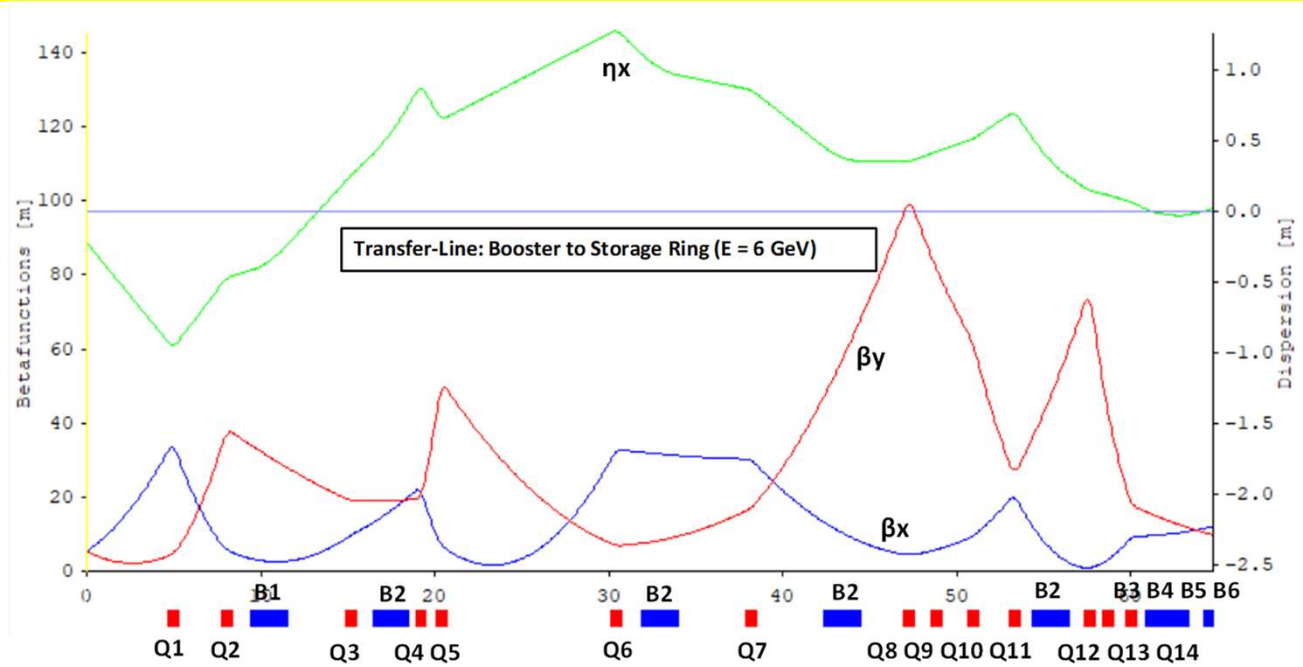


DI: $L = 0.3989$ m, $\rho = 3.05$ m, $\phi = 14.725^\circ$, $\phi_1 = \phi_2 = 7.36^\circ$, $B = 0.219$ T
 SI: $L = 0.528$ m, $\rho = 2.87$ m, $\phi = 10.5405^\circ$, $\phi_1 = \phi_2 = 5.27^\circ$, $B = 0.232$ T
 Q1: $L = 0.222$, $G = 0.334$ T/m, Q2 = Q6 = -Q7 = Q8 : $L = 0.22$ m, $G = -0.133$ T/m,
 Q3 = -Q4 : $L = 0.22$ m, $G = -0.334$ T/m, Q6 : $L = 0.22$ m, $G = 0.8$ T/m
 KI: $L = 0.528$ m



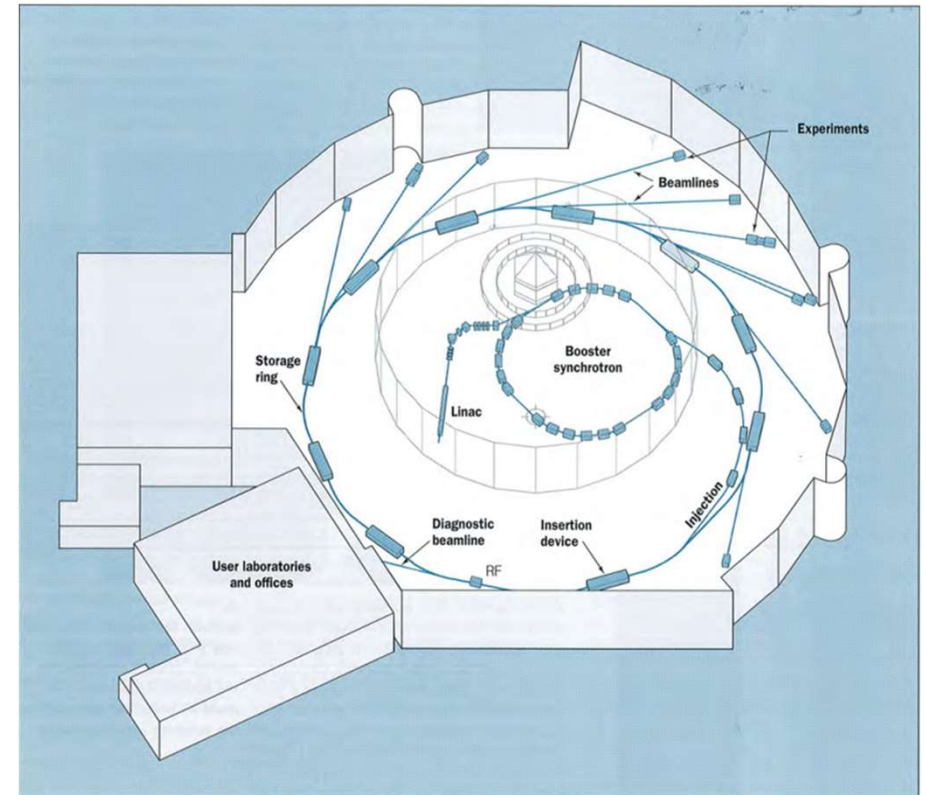
ESRF – Booster: BTS-Transfer-Line

Name	Length	Grad. (T/m)
Q1	0,6	11,16
Q2	0,6	-8,76
Q3	0,6	1,77
Q4	0,6	16,8
Q5	0,6	-13,87
Q6	0,6	7,27
Q7	0,6	2,79
Q8	0,6	-4,35
Q9	0,6	0,33
Q10	0,6	-2,66
Q11	0,6	12,7
Q12	0,6	-11,57
Q13	0,6	2,04
Q14	0,6	10,9



Length (m)	Name	Phi (°)	Rho (m)	Field (T)
2,094	B1	5,5233	21,72	0,921
2,094	B2	5,4545	22	0,91
0,9781	B3	2,5783	21,74	0,921
0,431	B4	-0,4068	-60,7	-0,33
0,9781	B5	2,65	21,14	0,947
1,3178	B6	1,3178	21,74	0,921

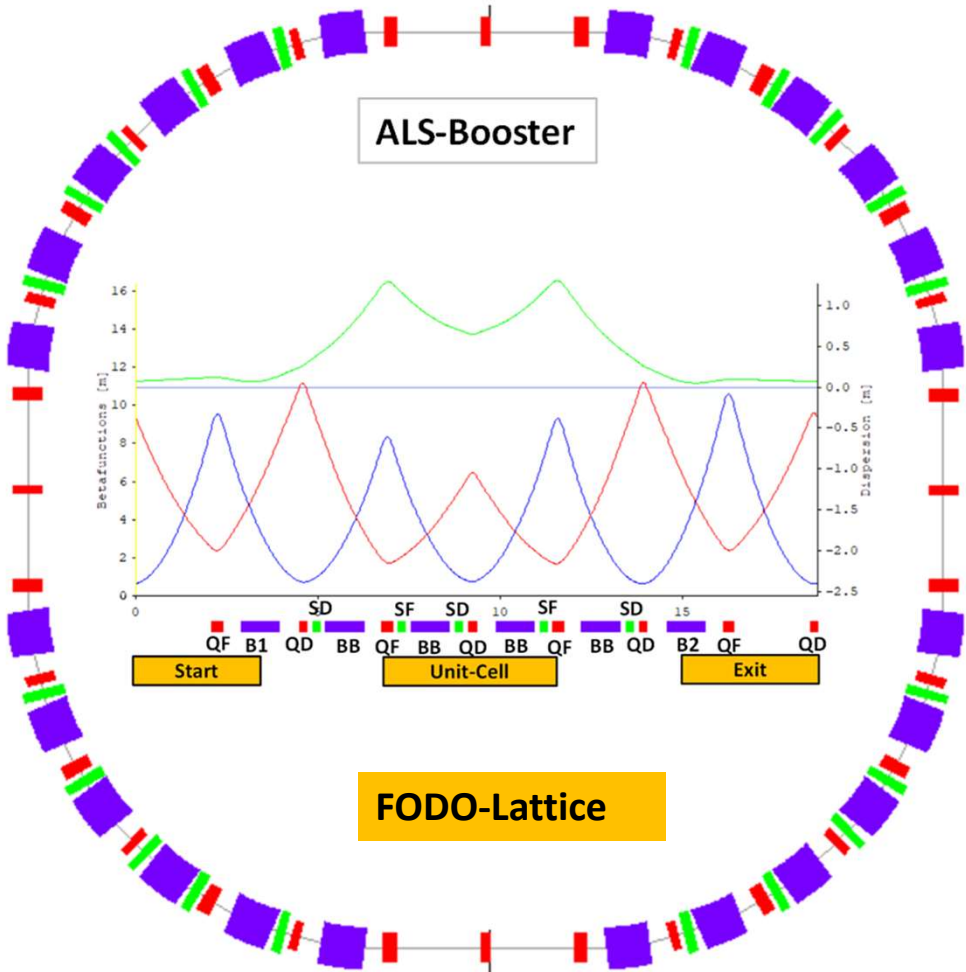
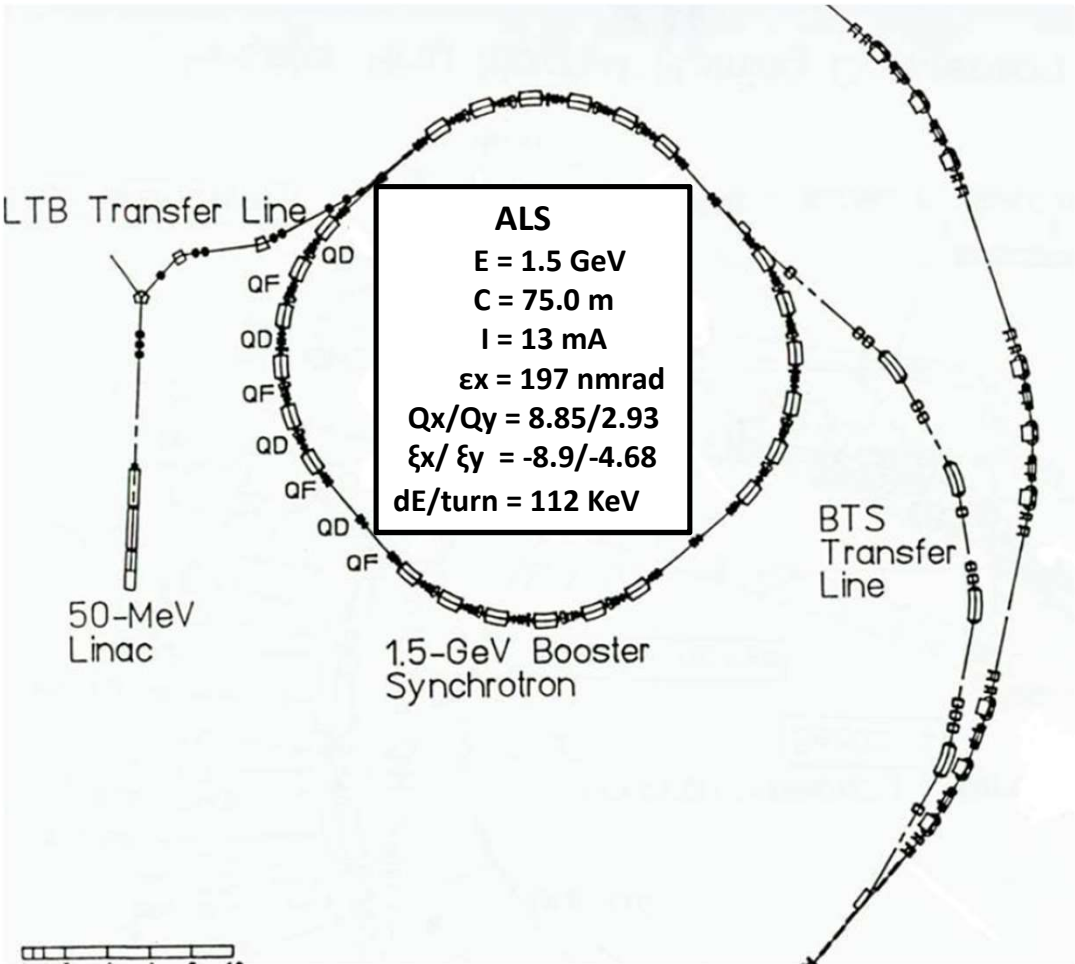
ALS – Injector (1993)



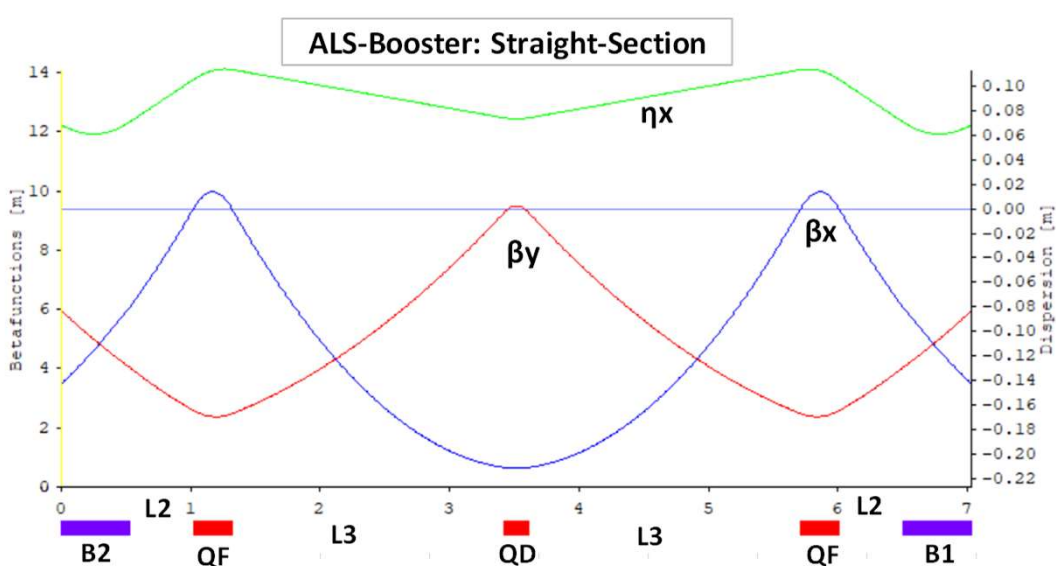
Christoph Steier

D. Einfeld, Karlsruhe, 7th March 2024

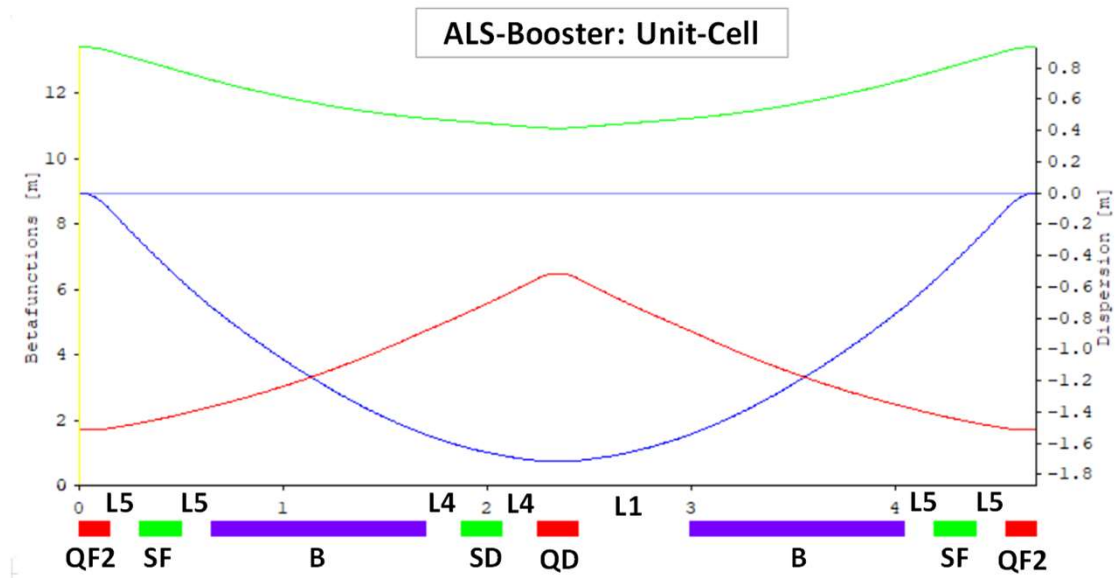
ALS – Injector



ALS – Booster-Lattice



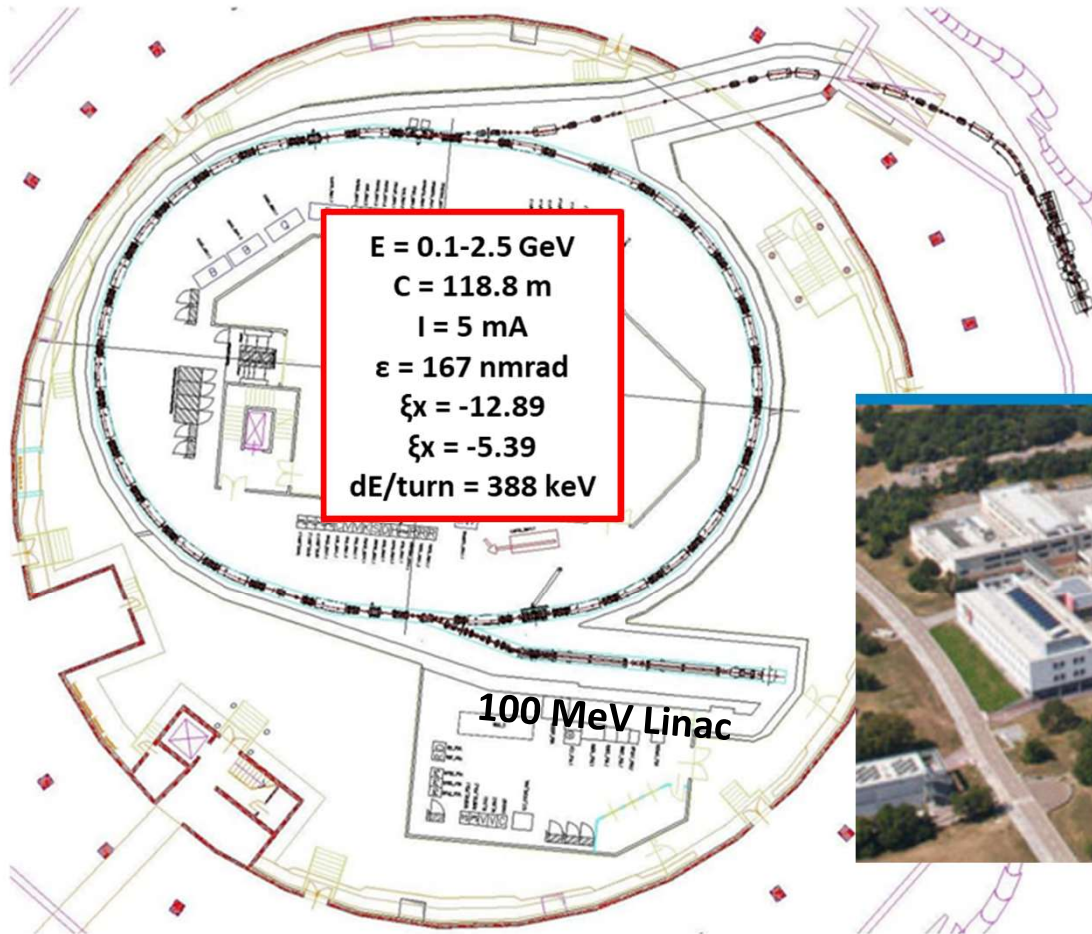
B1: $L = 0.525$ m, $\rho = 4.011$, $\phi = 7.5^\circ$, $\phi_1 = 7.5^\circ$, $\phi_2 = 0.0^\circ$, $B = 1.247$ T
 B2: $L = 0.525$ m, $\rho = 4.011$, $\phi = 7.5^\circ$, $\phi_1 = 0.0^\circ$, $\phi_2 = 7.5^\circ$, $B = 1.247$ T
 QF: $L = 0.3$ m, $G = 13.3$ T/m, QD: $L = 0,2$ m, $G = 12.71$ T/m
 L2: $L = 0.4968$ m, L3: $L = 2.0938$ m



B: $L = 1.05$ m, $\rho = 4.011$, $\phi = 15^\circ$, $\phi_1 = \phi_2 = 7.5^\circ$, $B = 1.247$ T
 QF: $L = 0.3$ m, $G = 13.3$ T/m, QF2 = QF/2, QD: $L = 0,2$ m, $G = 12.71$ T/m
 L1: $L = 0.547$ m, L4: $L = 0.1734$ m, L5: $L = 0.1485$ m

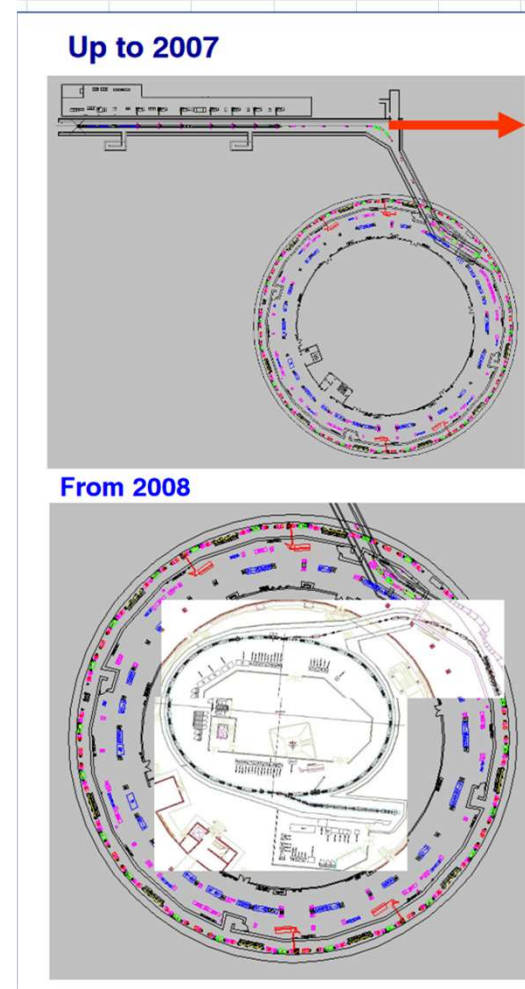
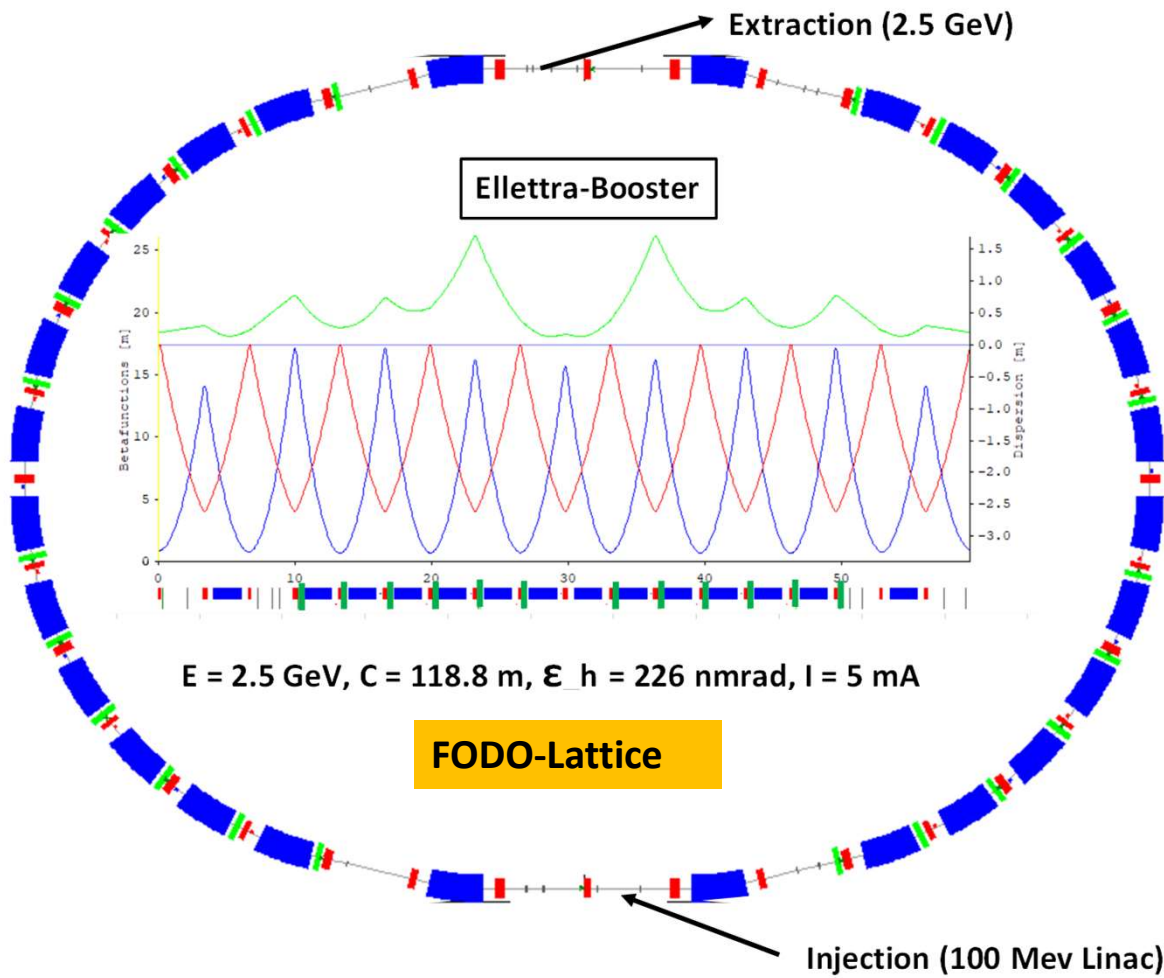
ELETTRA – Injector (1993 / 2008)

The lattice is the same as for APS (1995)

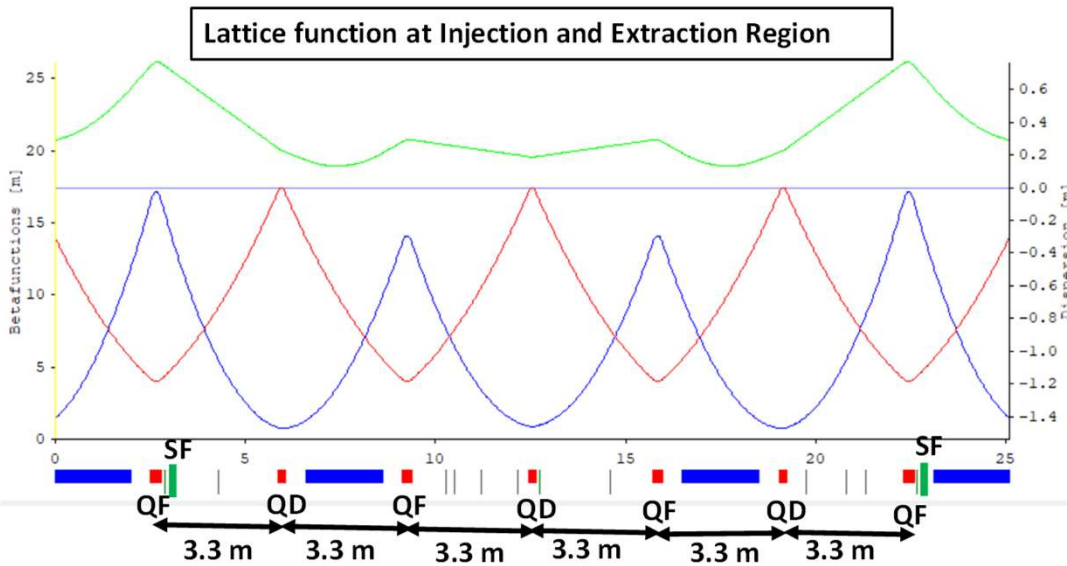


Stefano Krecic

ELETTRA – Booster (2008)



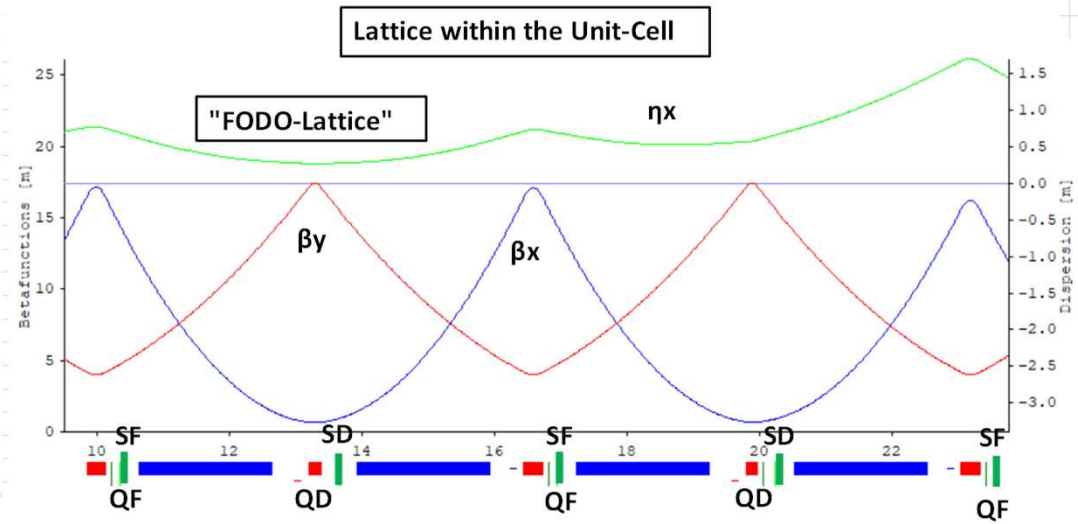
ELETTRA – Booster-Lattice



Bending: $L = 2\text{ m}$, $\phi = 12.857$ degrees, $\rho = 8.909\text{ m}$, $B = 0.936\text{ T}$

QF: $L = 0.28\text{ m}$, $k = 2.033$, $G = 16.95\text{ T/m}$ QD: $L = 0.175\text{ m}$, $k = -2.0022$, $G = 16.86\text{ T/m}$

SF: $L = 0.2\text{ m}$, $m = 5,575$, $B'' = 43\text{ T/m}^2$

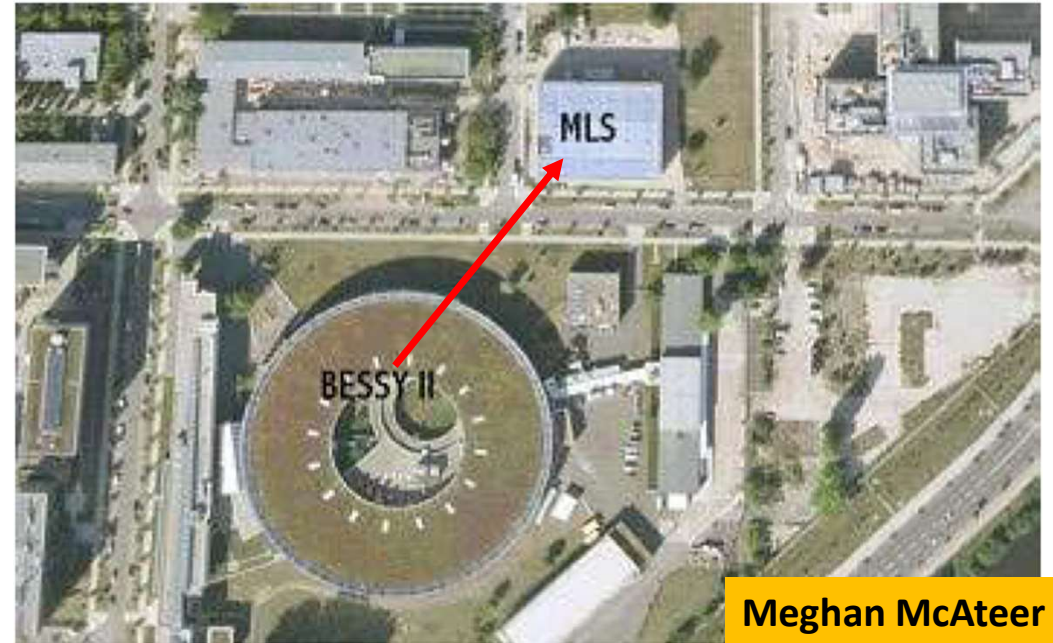


SF: $L = 0.2\text{ m}$, $B'' = 43\text{ T/m}^2$ SD: $L = 0.2\text{ m}$, $B'' = 65\text{ T/m}^2$

BESSY II – Booster (1997)



MLS:
Metrology Light SOURCE



Meghan McAteer

D. Einfeld, Karlsruhe, 7th March 2024

BESSY II - Booster

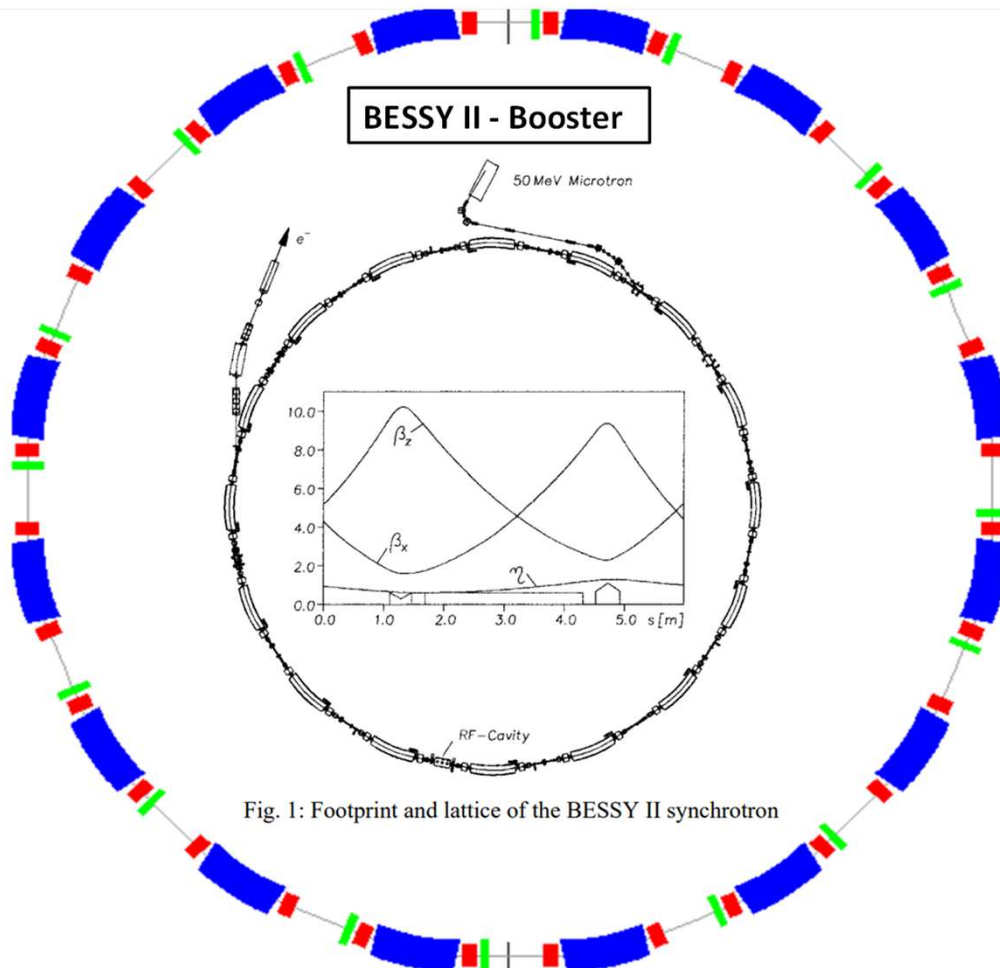
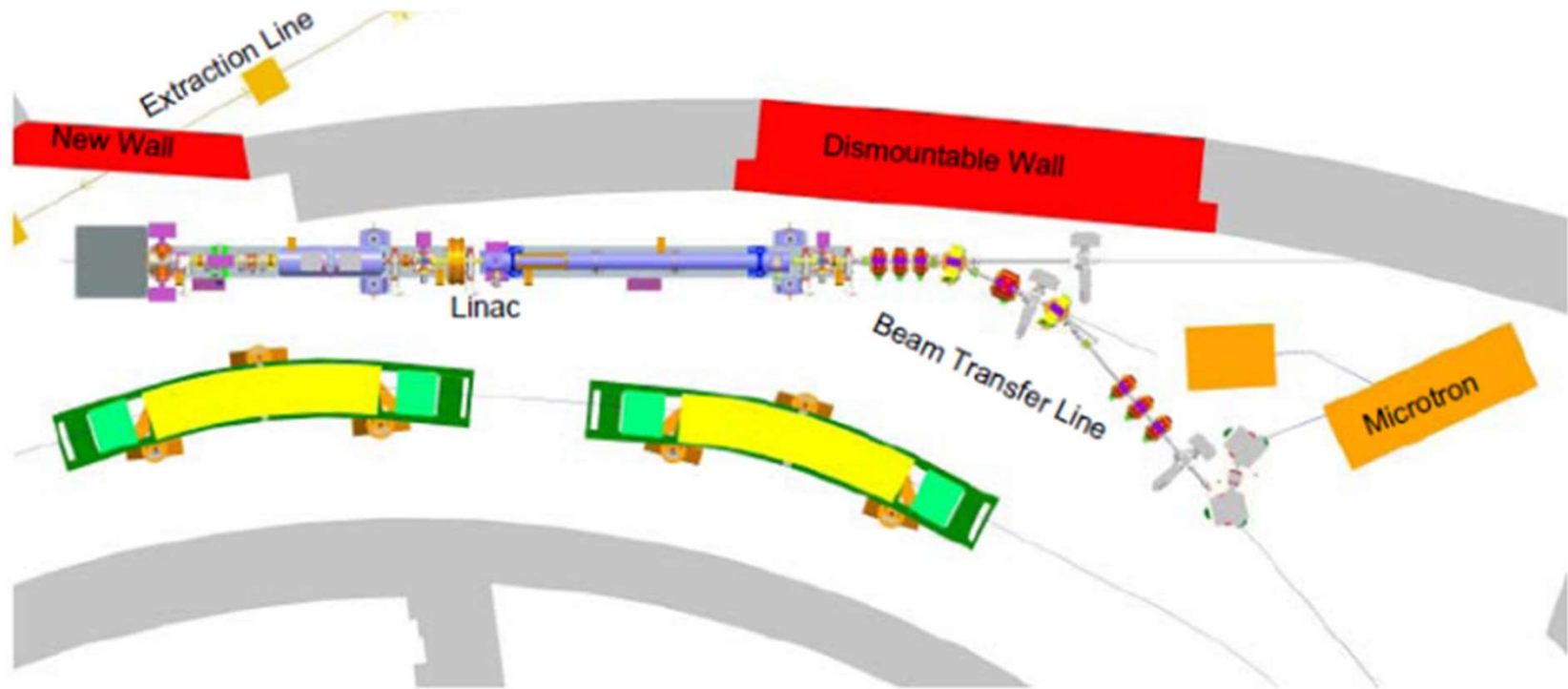


Fig. 1: Footprint and lattice of the BESSY II synchrotron

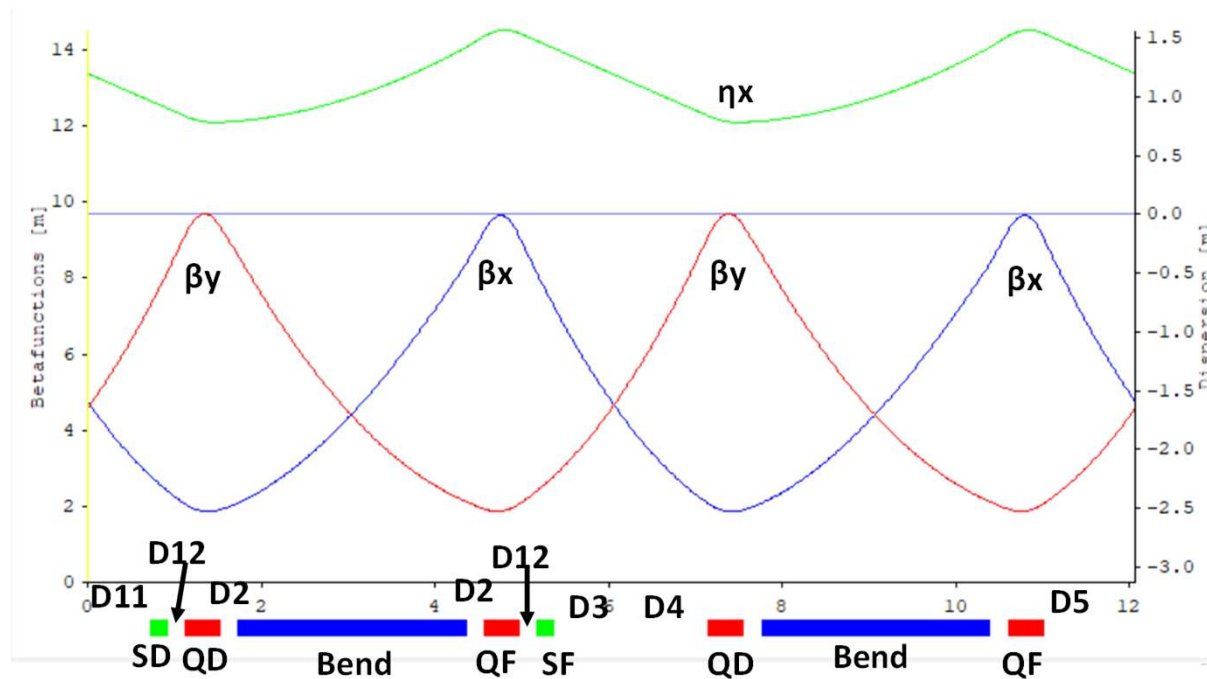
BESSY II -Booster
 $E = 0.1 - 2.0 \text{ GeV}$
 $C = 96 \text{ m}$
 $I = 3 \text{ mA}$
 $\epsilon = 200 \text{ nrad}$
 $Q_x = 4.42$
 $Q_y = 3.38$
 $\xi_x = -4.7$
 $\xi_y = -3.9$
 $dE/\text{turn} = 388 \text{ keV}$

Magnet	Number	Strength	Length	Gap/Radius
Dipoles	16	1. T	2621 mm	$h = 36 \text{ mm}$
Quads	32	14. T/m	300 mm	$r = 35 \text{ mm}$
Sext.	16	70 T/m ²	150 mm	$r = 35 \text{ mm}$
Steerer	16	0.05 T	150 mm	$h = 120 \text{ mm}$

BESSY II - Booster



BESSY II – Booster: Unit-Cell



Bend: $L = 2.61 \text{ m}$, $\phi = 22.5^\circ$, $\rho = 6.67 \text{ m}$, $B = 1.0 \text{ T}$

QF: $L = 0.4 \text{ m}$, $k = 1.235$, $G = 8.46 \text{ T/m}$, QD: $L = 0.4 \text{ m}$, $k = -1.157$, $G = -7.97 \text{ T/m}$

SF: $L = 0.2 \text{ m}$, $B'' = 34.2 \text{ T/m}^2$, SD: $L = 0.2 \text{ m}$, $B'' = -53 \text{ T/m}^2$

D11: $L = 0.72 \text{ m}$, D12: $L = 0.2 \text{ m}$, D2: $L = 0.215 \text{ m}$, D3: $L = 0.66 \text{ m}$, D4: $L = 1.12 \text{ m}$, D5: $L = 1.06 \text{ m}$

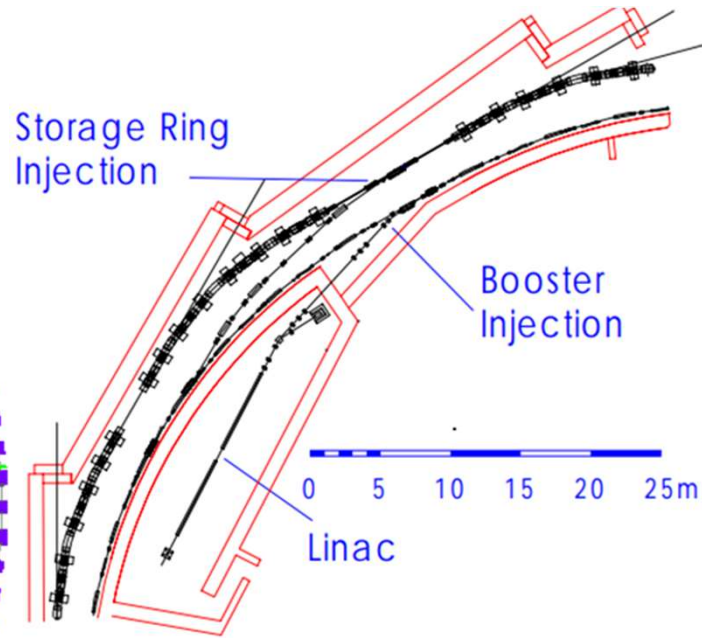
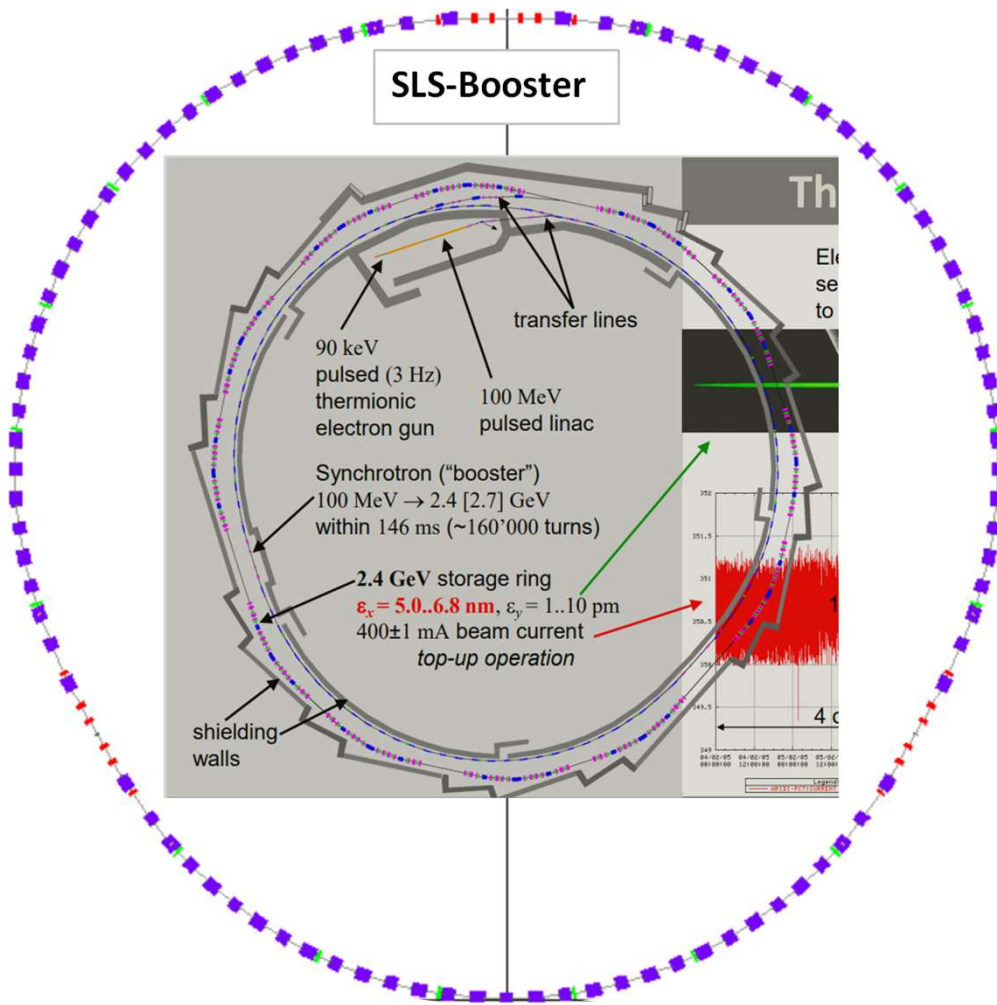
Paul Scherrer Institut: SLS – Booster (2001)



Jonas Kallestrup

D. Einfeld, Karlsruhe, 7th March 2024

SLS - Booster

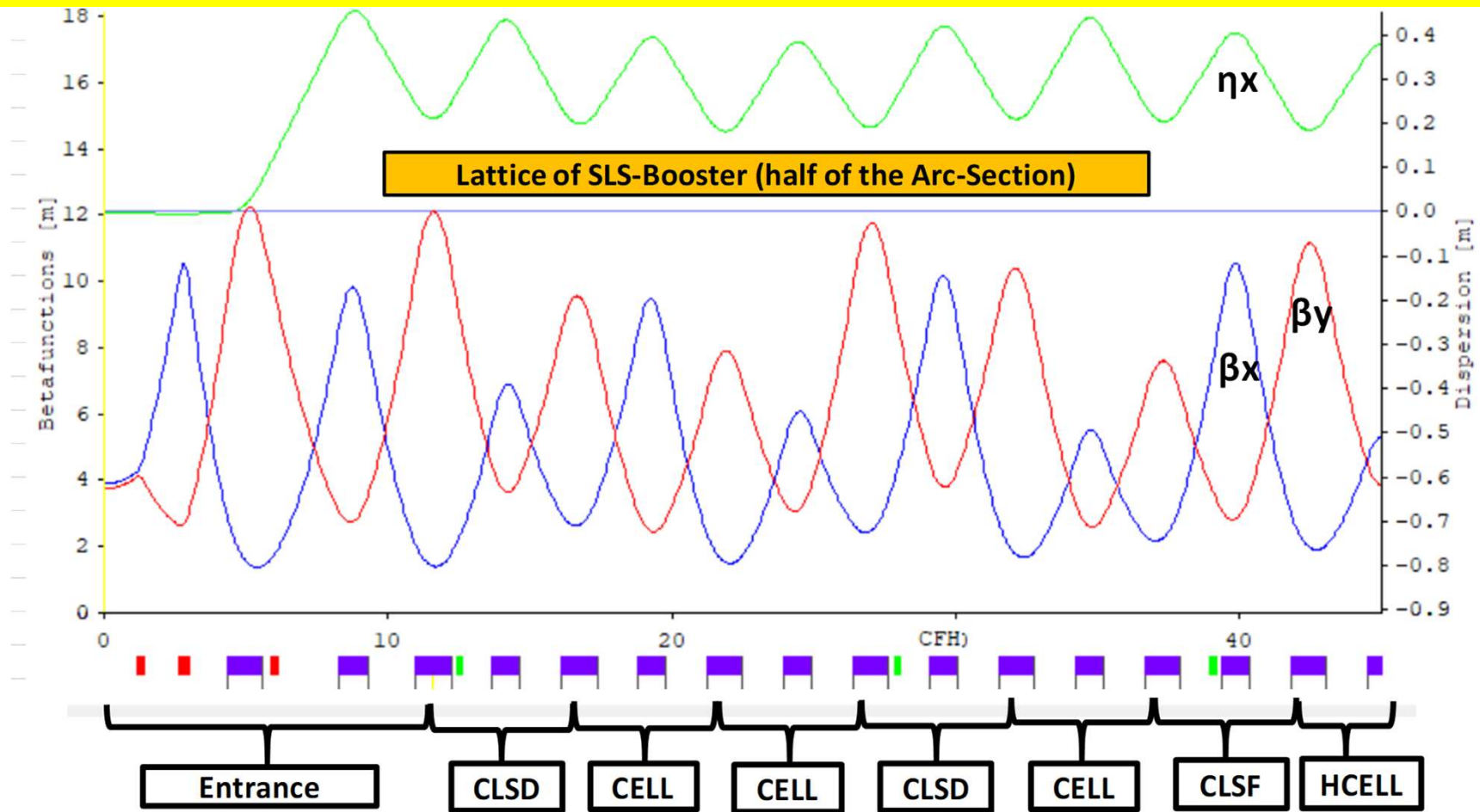


E = 0.1-2.4 GeV
C = 270 m
I = 12 mA
 $\epsilon = 9.1$ nmrad
 $\xi_x = -14.6$
 $\xi_x = -11.6$
dE/turn = 233 keV

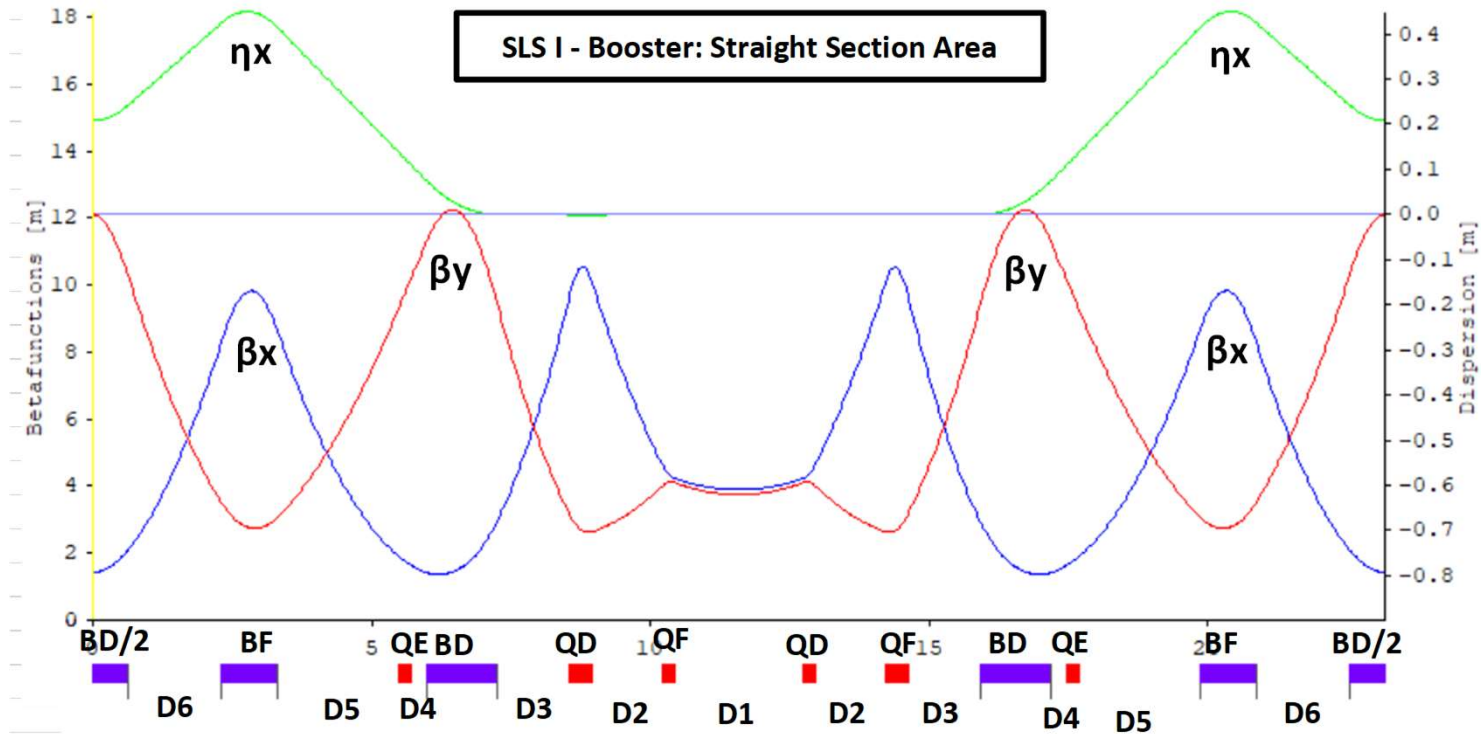
Figure 1: Layout of the tunnel, showing the storage ring, booster, linac and the transfer lines.

At SLS it was for the first time to build the storage ring and the booster in the same tunnel.

SLS - Booster



SLS - Booster



BF: $L = 1$ m, $\phi = 1.1296$, $B = 0.157$ T, $\rho = 50.72$ m, $G = 4.66$ T/m, $B'' = 15.0$ T/m³, CFH = half of CF
 BD: $L = 1.26$ m, $\phi = 6.441$, $B = 0.714$ T, $\rho = 11.21$ m, $G = 3.09$ T/m, $B'' = 19.5$ T/m³, CFH = half of CF
 QD: $L = 0.22$ m, $G = 3.09$ T/m, QF: $L = 0.4$ m, $G = 12.25$ T/m, QE: $L = 0.22$ m, $G = 0.8$ T/m
 D1: $L = 2.32$ m, D2: $L = 1.25$ m, D3: $L = 1.31$ m, D4: $L = 0.29$ m, D5: $L = 2.17$ m, D6 = 1.68 m

SLS - Booster

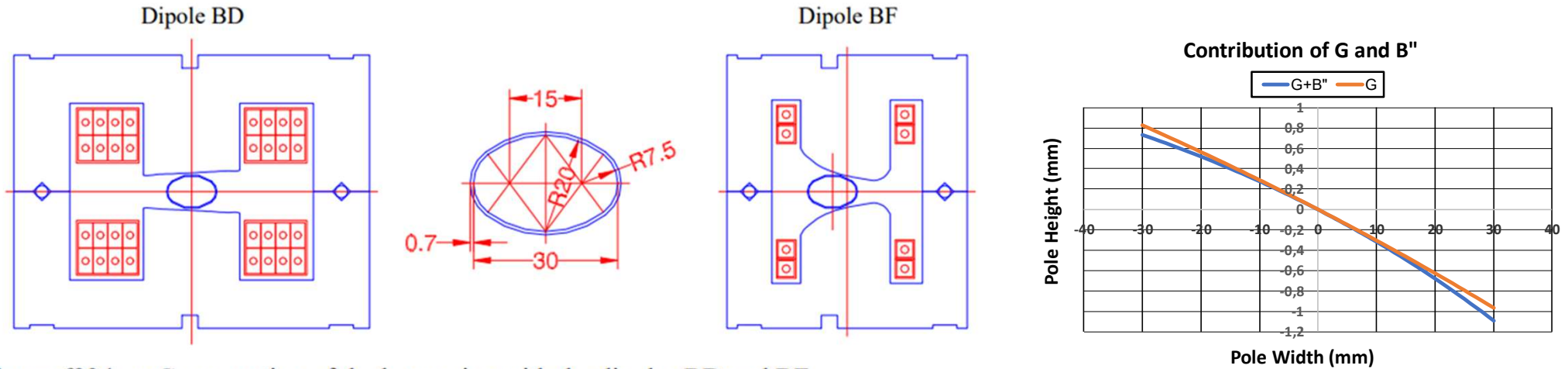
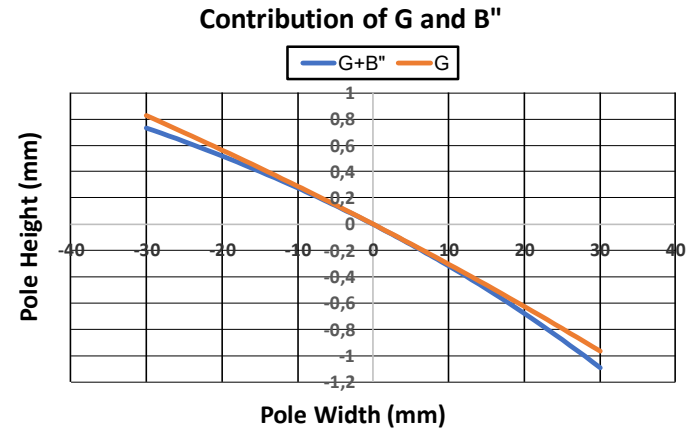


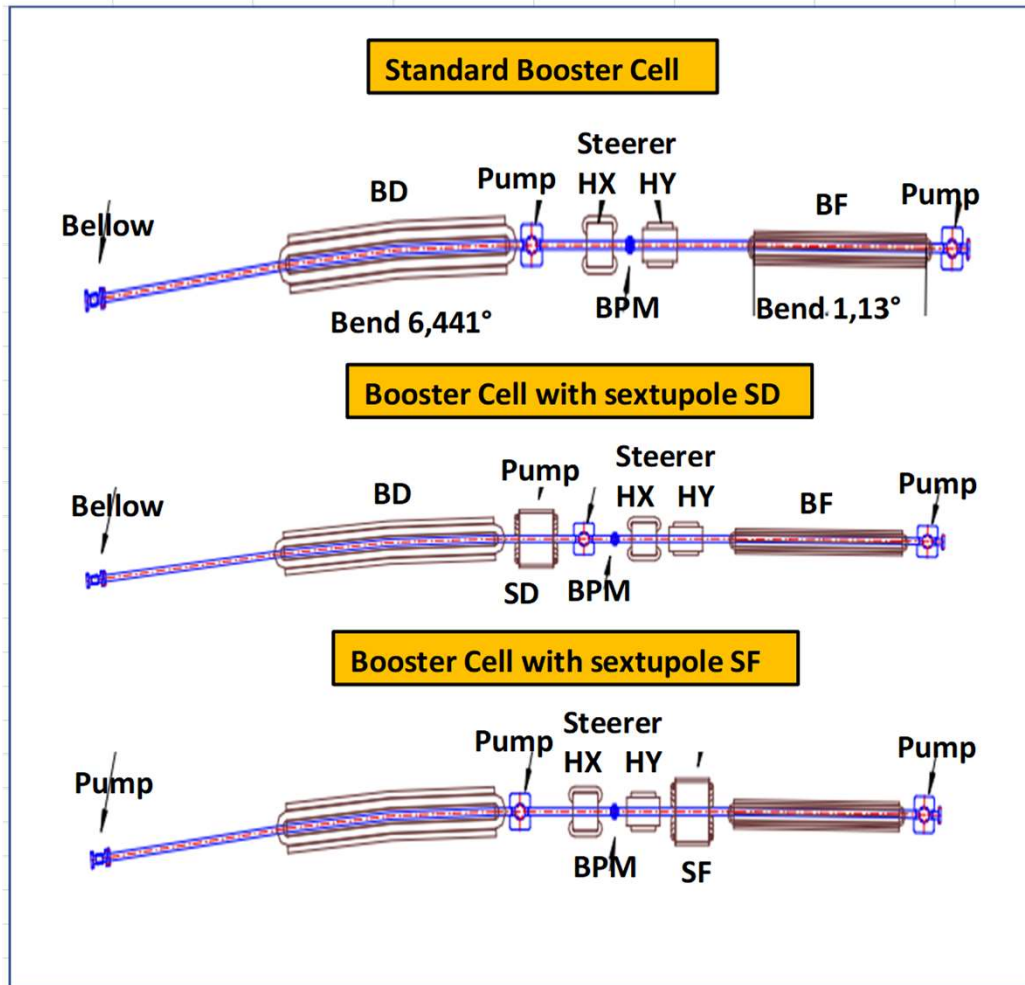
Figure f324 a: Cross section of the beam pipe with the dipoles BD and BF.

Dipoles (comb. function)	BD	BF
Total number	48	45
magnetic length	1.26 m	1.0 m
Bend angle	6.441°	1.1296°
Bend radius	11.21 m	50.72 m
gap at beam center	23.3 mm	26.45 mm
maximum field at 2.4 GeV	0.714 T	0.158 T
maximum gradient	-3.09 T/m	4.66 T/m
max. sext. gradient B_θ/a^2	-10 T/m ²	7 T/m ²
turns/pole	8	2
maximum current	840A	840A
average power	2.2 kW	0.6 kW
weight	300 kg	160 kg

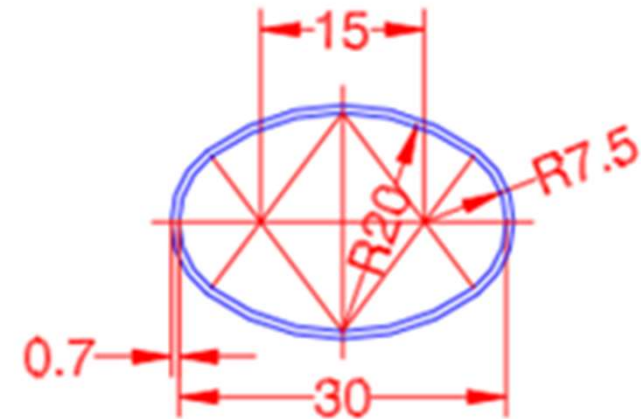
Booster Quads	type	long	short
number of quads		6	12
magnetic length		0.4 m	0.22 m
iron length		0.38 m	0.2 m
aperture radius a		18 mm	18 mm
max. gradient at 2.4 GeV		16 T/m	16 T/m
max. poletip field		0.29 T	0.29 T
number of turns/pole		15	15
resistance		65 mΩ	40 mΩ
inductance		5 mH	3 mH
max. current		140 A	140 A
max. voltage		15 V	10 V
max. average power		0.5 kW	0.3 kW
weight		130 kg	70 kg



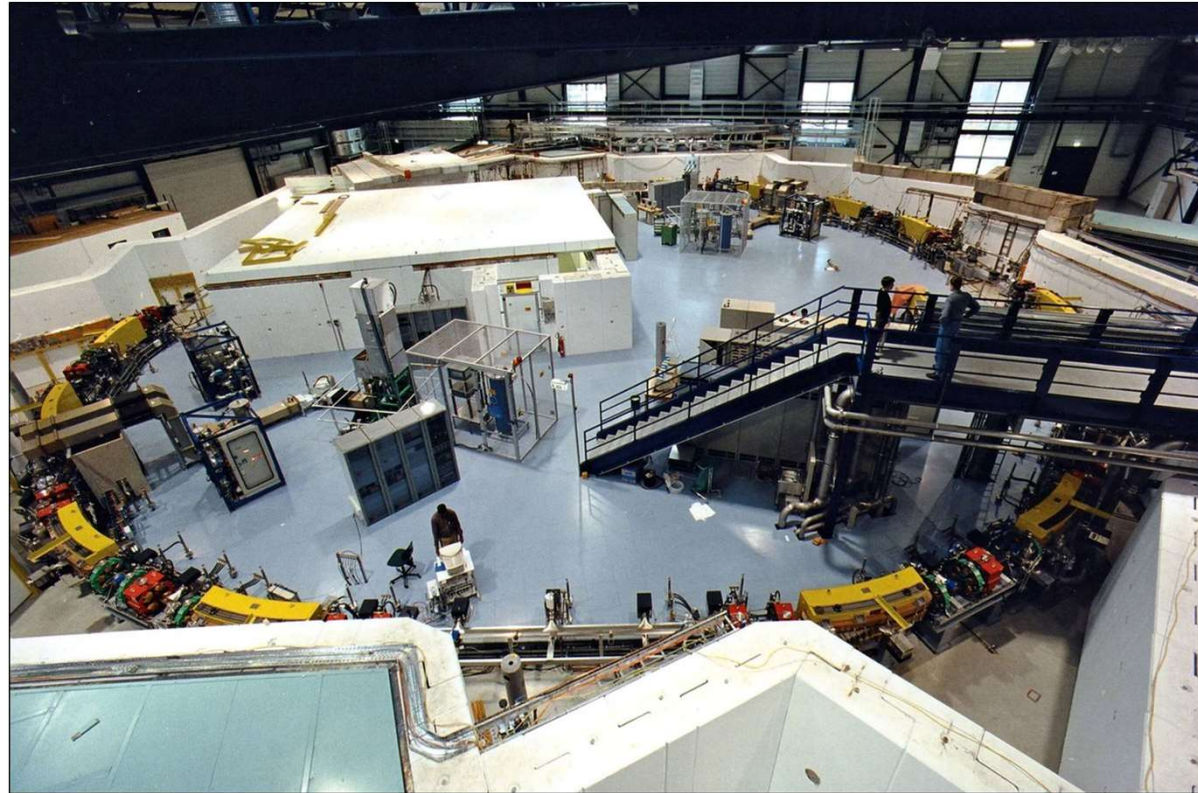
SLS – Booster: Vacuum System



Top view of the FODO cells in the SLS booster with the dipoles BD and BF. After each dipole a small pump is installed

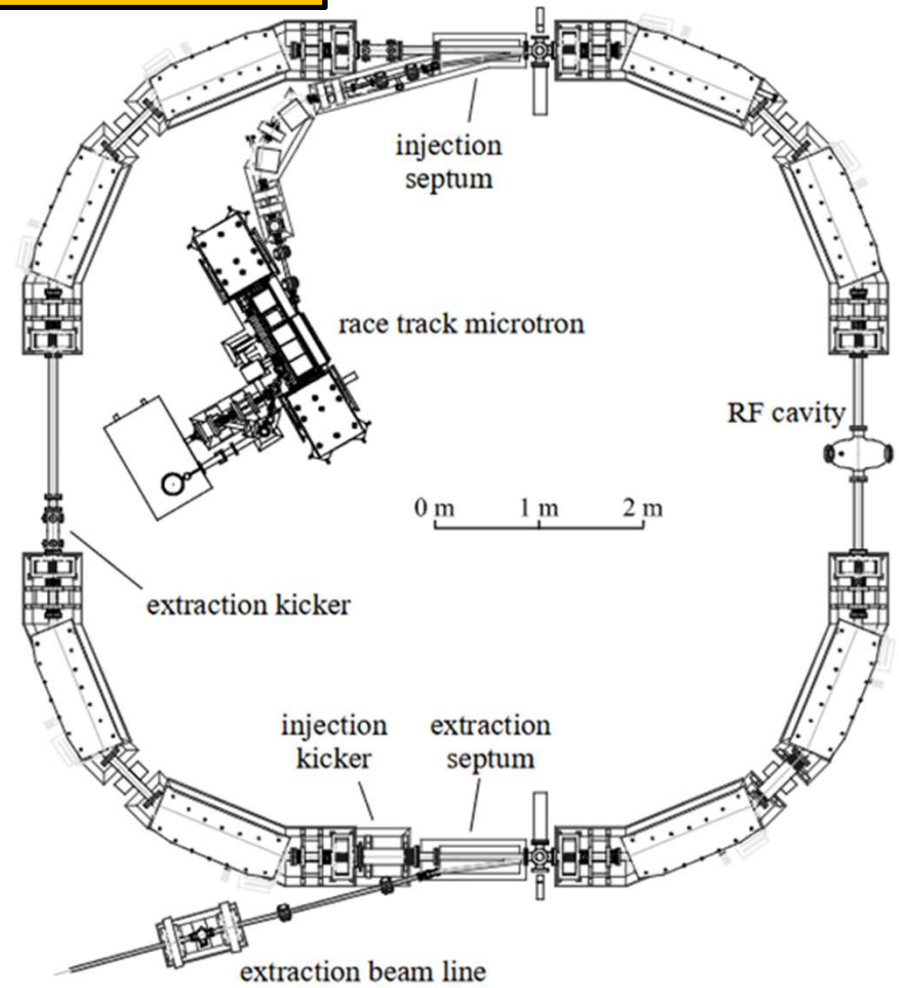
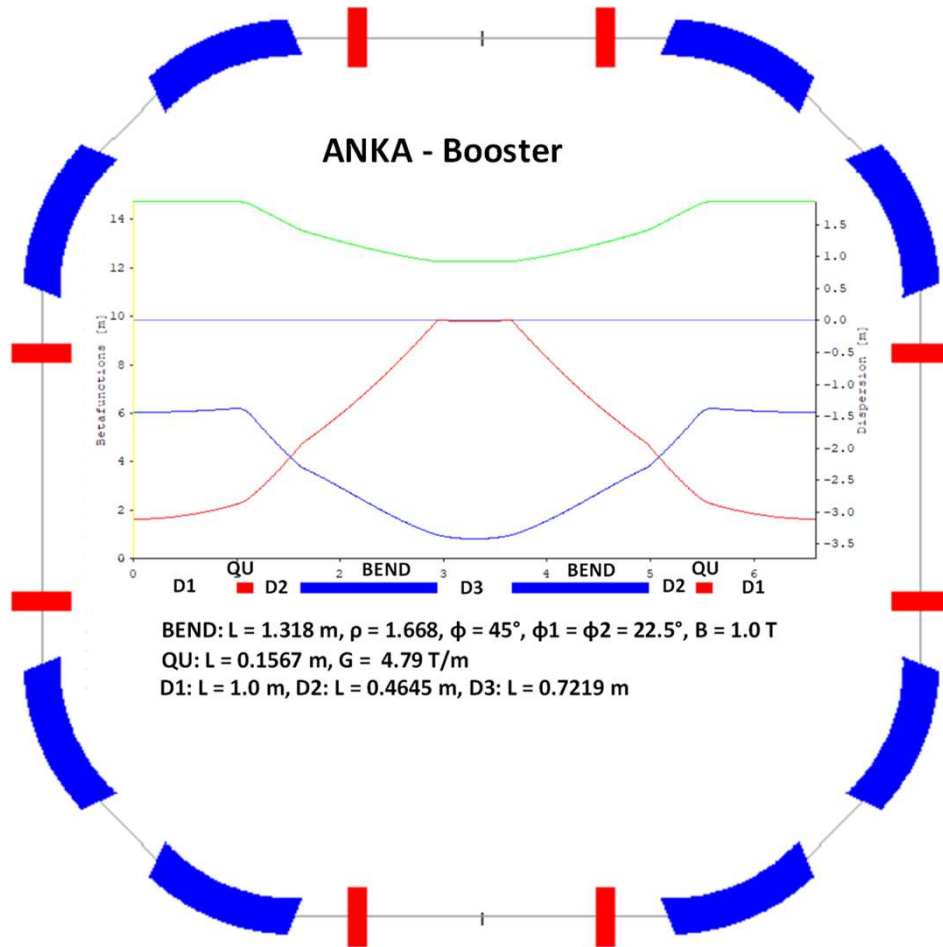


ANKA / KARA (2001)



ANKA - Booster

The Booster was built by Danfysik



ANKA - Booster



D. Einfeld, Karlsruhe, 7th March 2024

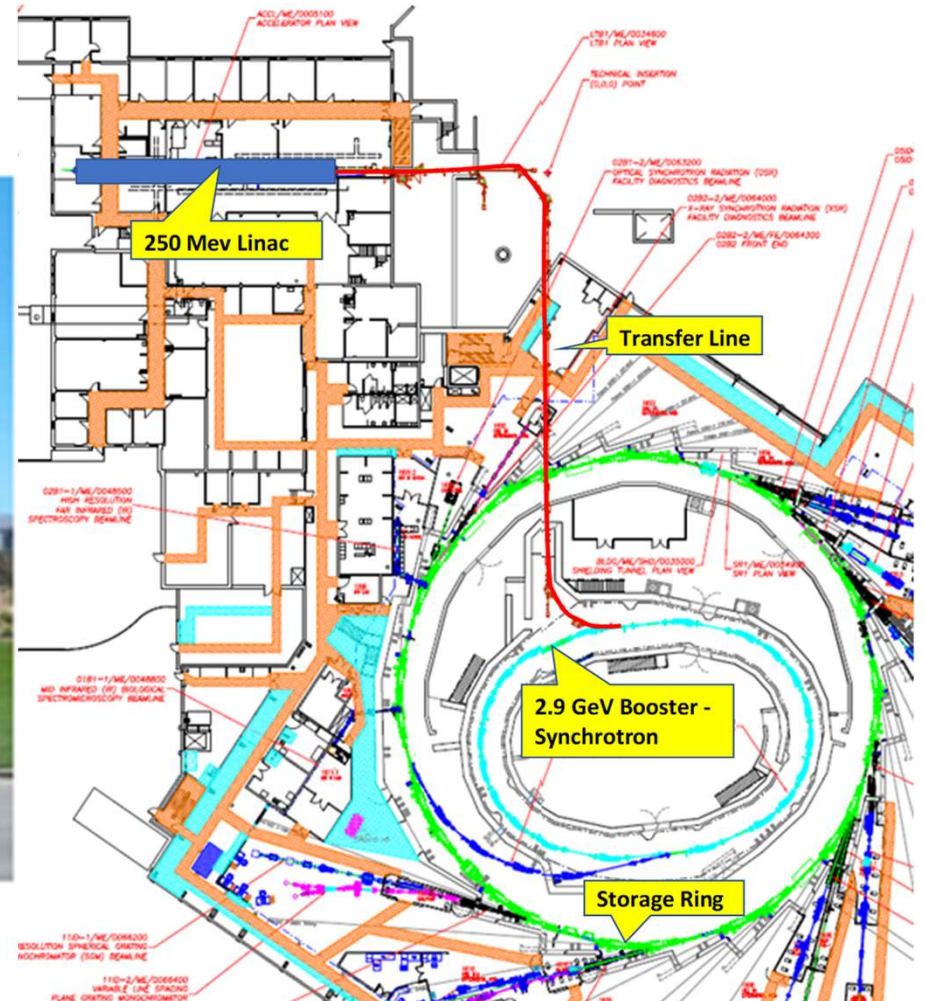
Canadian Light Source (CLS) – Injector (2006)

The lattice is the same as for Diamond (2006) and for SOLEIL (2006)

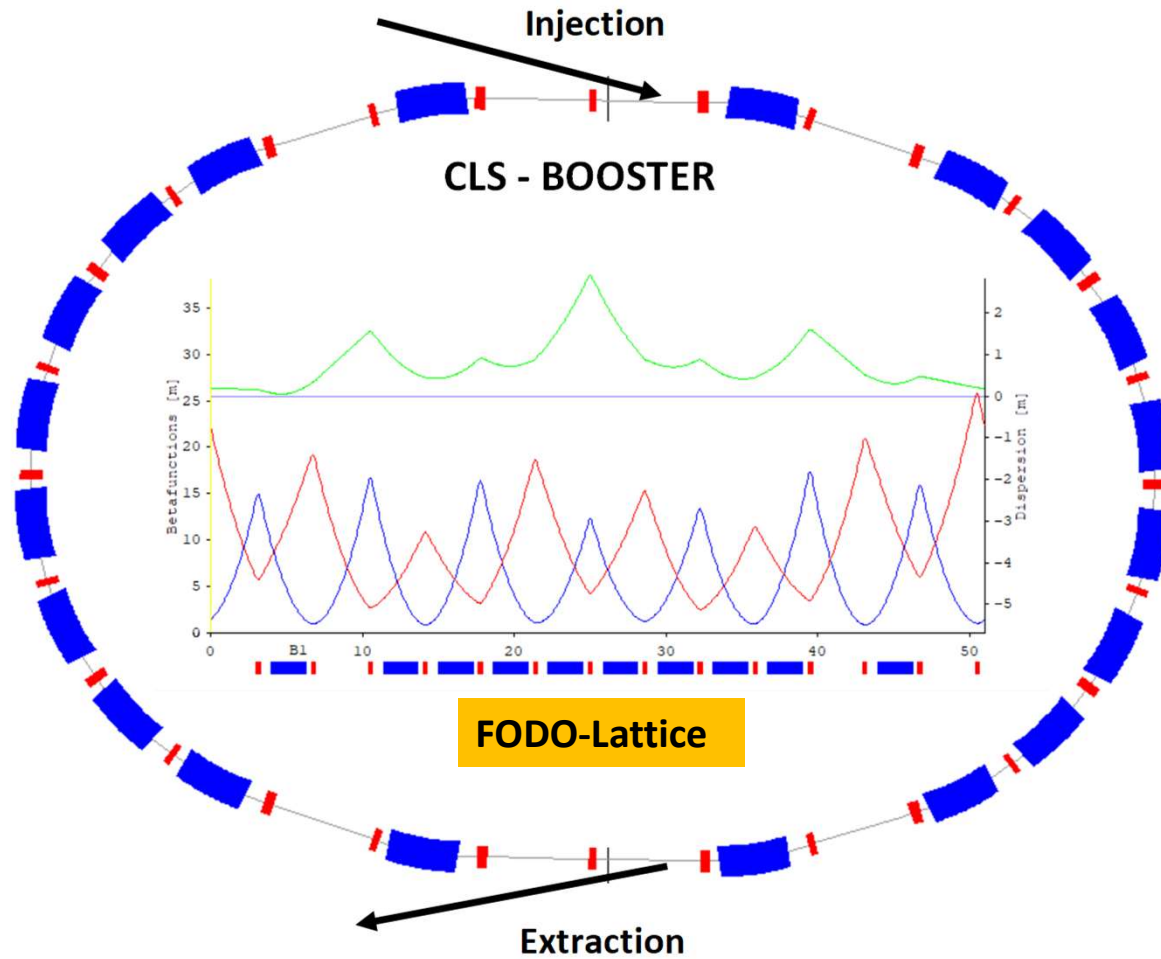


Figure 8. CLS Building.

The booster was built by Danfysik

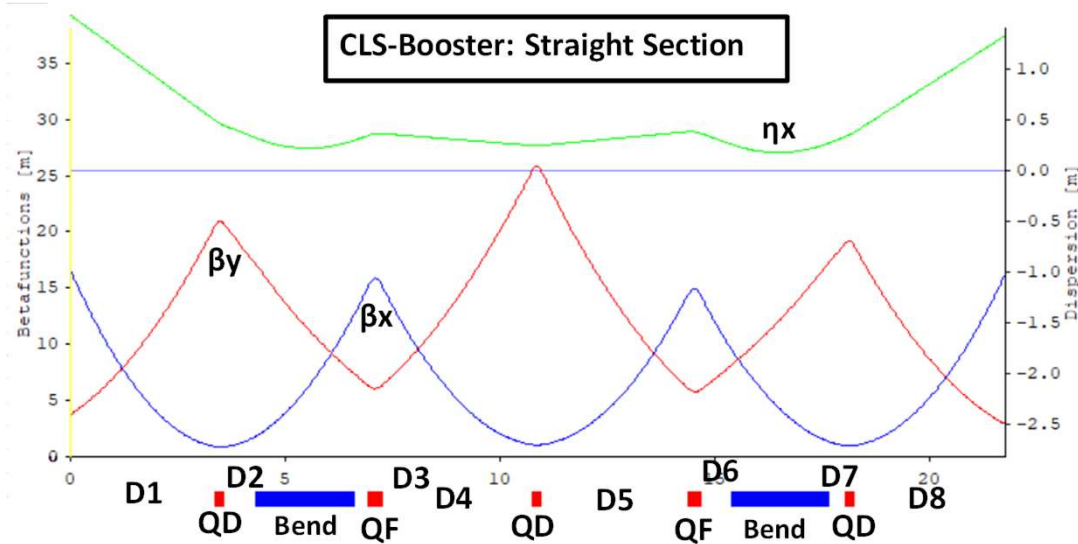


CLS – Injector: Layout and Parameters

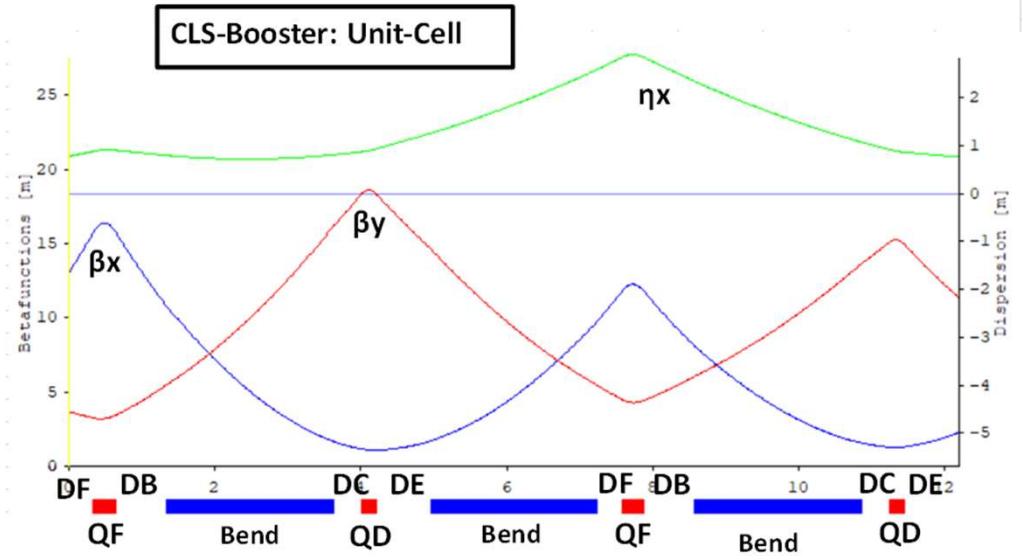


CLS
E = 2.9 GeV
C = 102.528 m
I = >10 mA
 $\epsilon = 523$ nrad
Qx = 5.18
QY = 2.38
 $\xi_x = -6.87$
 $\xi_x = -4.03$
dE/turn = 863 keV

CLS - Booster



Bend: $L = 2.61 \text{ m}$, $\phi = 22.5^\circ$, $\rho = 6.67 \text{ m}$, $B = 1.45 \text{ T}$
 QF: $L = 0.3 \text{ m}$, $G = 14.61 \text{ T/m}$, $QD = 0.2 \text{ m}$, $G = -16.49 \text{ T/m}$
 $D1 = 3.37 \text{ m}$, $D2 = 0.75 \text{ m}$, $D3 = 0.335 \text{ m}$, $D4: L = 3.516 \text{ m}$, $D5: L = 3.42 \text{ m}$,
 $D6 = 0.705 \text{ m}$, $D7 = 0.385 \text{ m}$, $D8 = 3.516 \text{ m}$



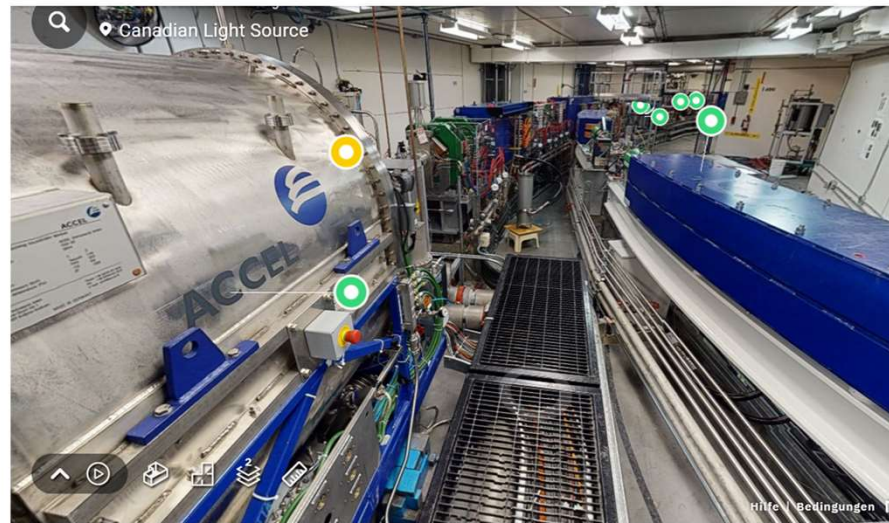
Bend: $L = 2.61 \text{ m}$, $\phi = 22.5^\circ$, $\rho = 6.67 \text{ m}$
 QF: $L = 0.3 \text{ m}$, $G = 14.61 \text{ T/m}$, $QD = 0.2 \text{ m}$, $G = -16.49 \text{ T/m}$
 $DF = 0.335 \text{ m}$, $DB = 0.705 \text{ m}$, $DC = 0.385 \text{ m}$, $DE: L = 0.755 \text{ m}$

Sextupole magnets are not implemented in the lattice for correction of the natural chromaticity's to positive values since the head-tail is not considered to cause any problems for beam current below $\approx 50 \text{ mA}$

CLS - Booster



Figure 5: Fully installed section of the booster synchrotron with 4 girder.



ASP/ANSTO – Booster (2007)

The lattice is the same as for NSLS II (2015)

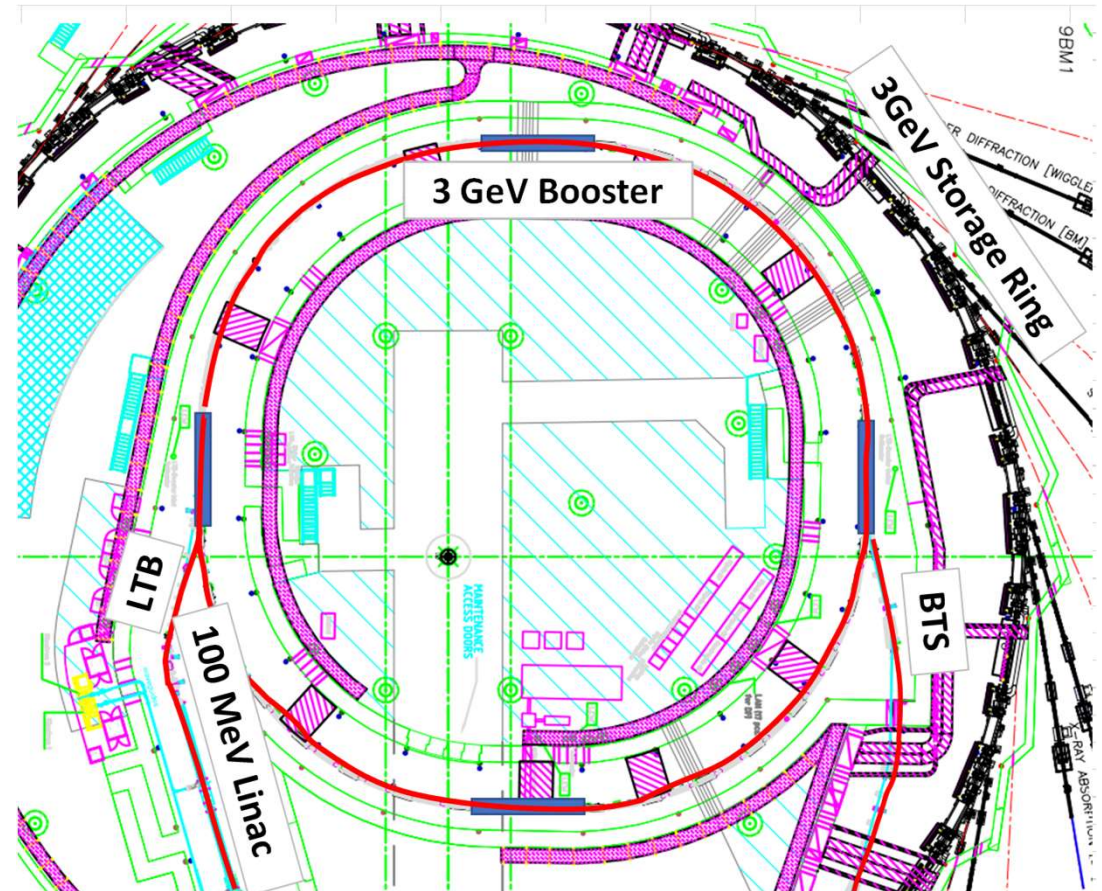
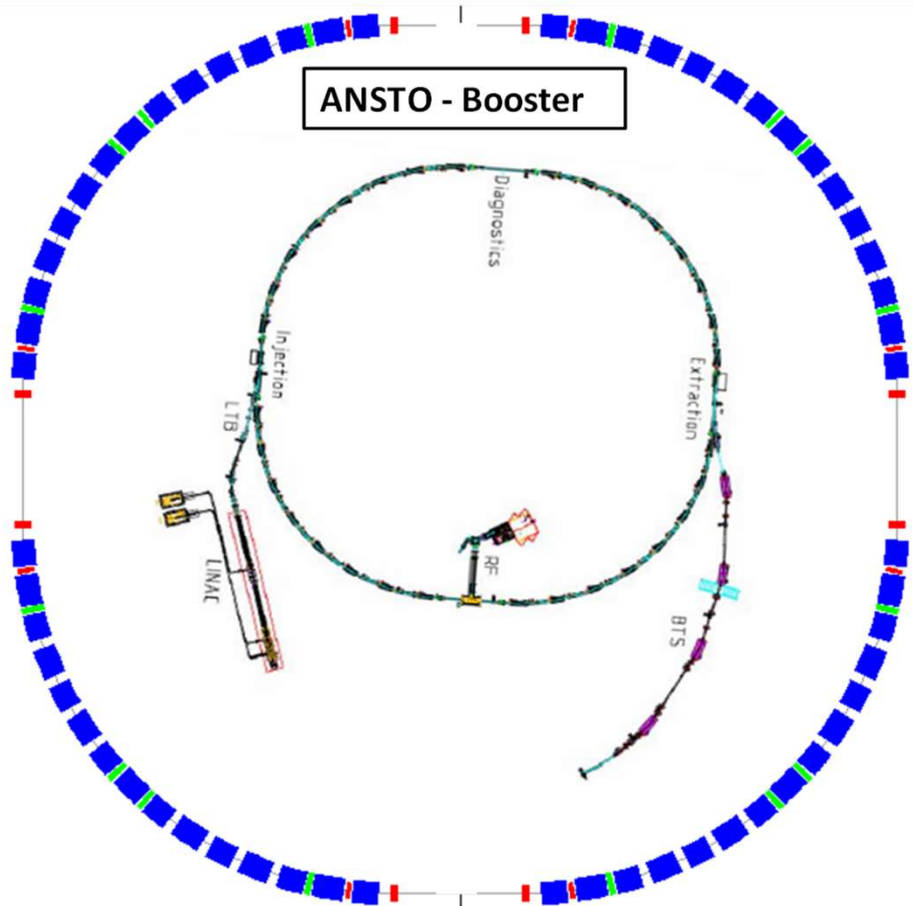
Australian Synchrotron Project Turn-key booster



Lattice:	Combined function
Booster circumference:	130m
Injection energy:	100MeV
Peak energy:	3.0GeV
Beam current (multi bunch train):	5mA
Cycle rate:	1Hz

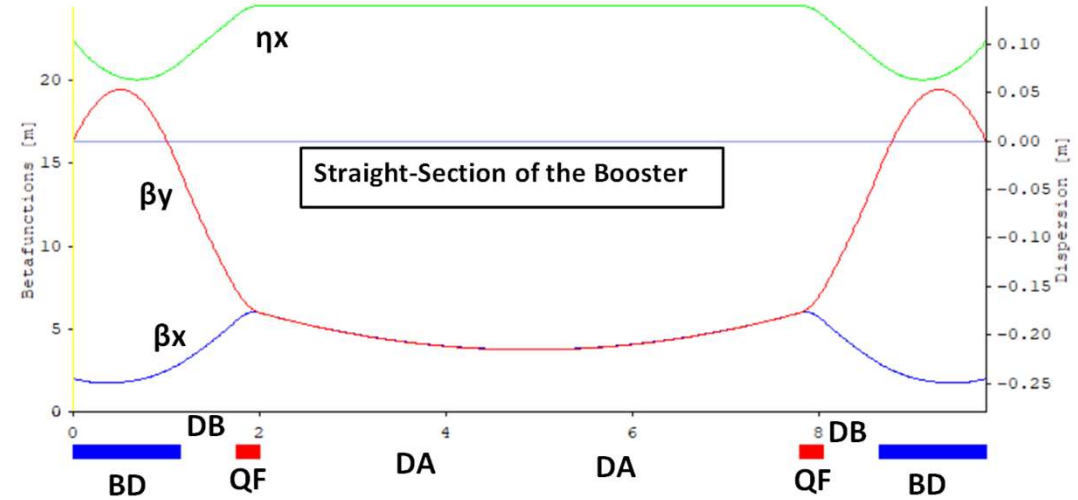
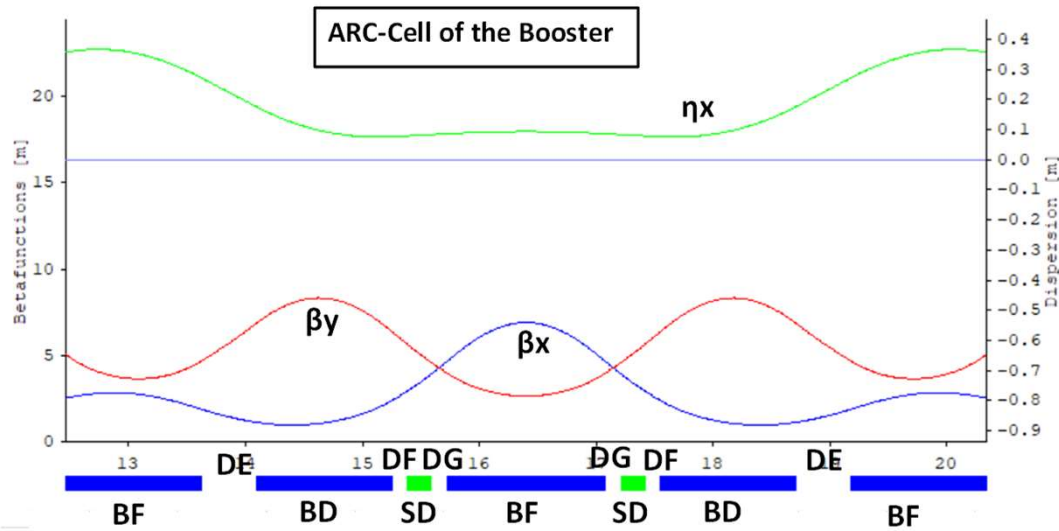


ASP/ANSTO - Booster



The Booster was built by Danfysik

ASP/ANSTO - Booster



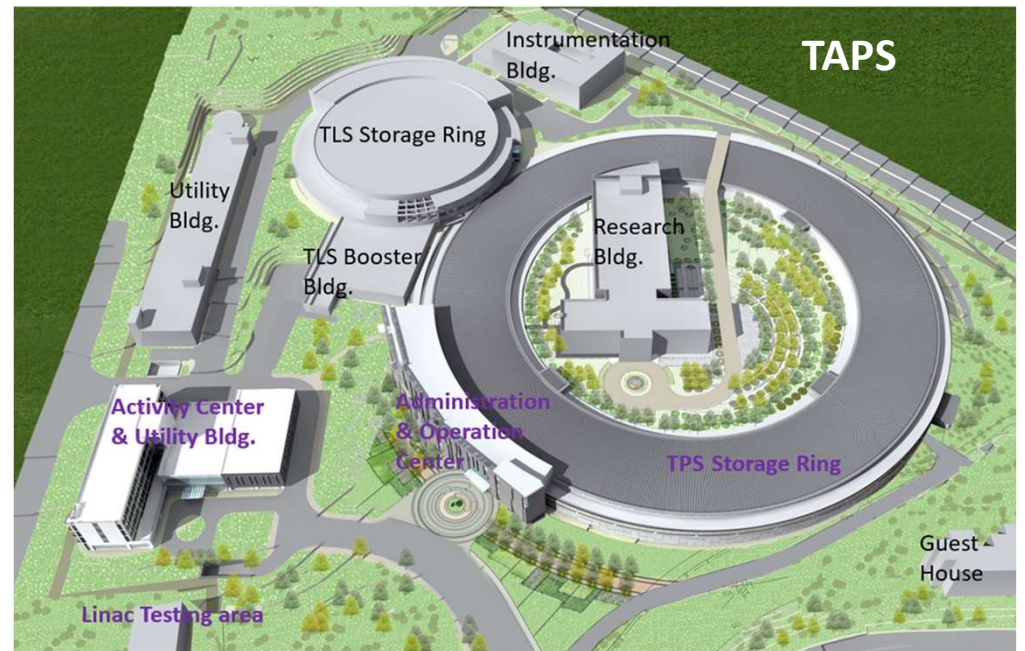
BD: $L = 1.15 \text{ m}$, $\phi = 8.25^\circ$, $\rho = 7.99 \text{ m}$, $B = 1.25\text{T}$, $G = -6.7 \text{ T/m}$,
 $B'' = -49.3 \text{ T/m}^2$
 QF: $L = 0.25 \text{ m}$, $G = 23.51 \text{ T/m}$
 DA = 2.894 m, DB = 0.6 m

BF: $L = 1.35 \text{ m}$, $\phi = 3.429^\circ$, $\rho = 22.357 \text{ m}$, $B = 0.444 \text{ T}$, $G = 8.26 \text{ T/m}$,
 $B'' = -35.41 \text{ T/m}^2$
 BD: $L = 1.15 \text{ m}$, $\phi = 8.25^\circ$, $\rho = 7.99 \text{ m}$, $B = 1.25\text{T}$, $G = -6.7 \text{ T/m}$,
 $B'' = -49.3 \text{ T/m}^2$
 SD: $L = 0.20 \text{ m}$, $B'' = 393 \text{ T/m}^2$, SD: $L = 0.16 \text{ m}$, $B'' = -73.35 \text{ T/m}$
 DE = 0.3 m, DF = 0.12 m, DG = 0.24 m

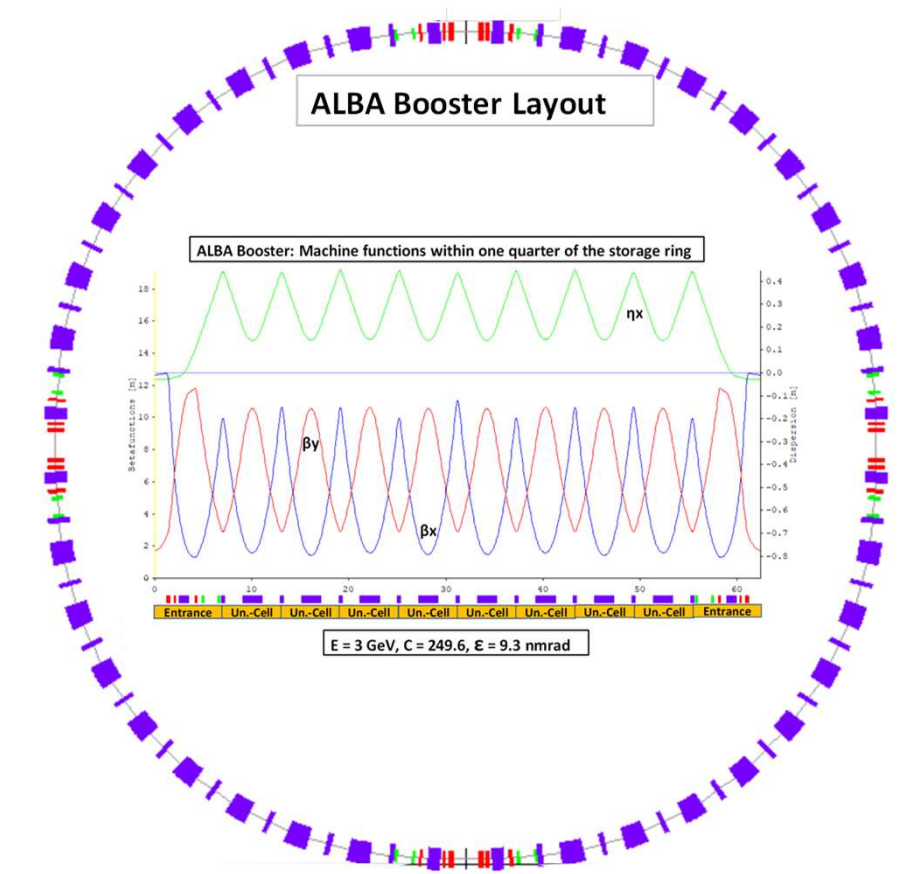
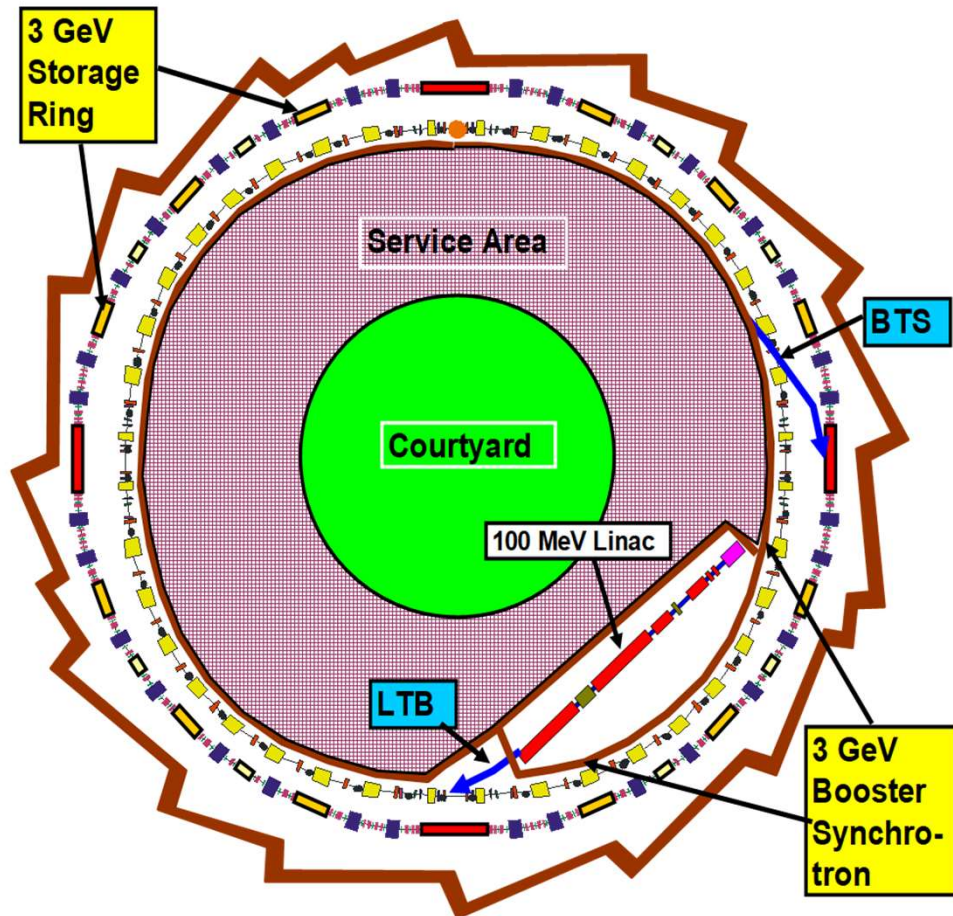
ALBA – Injector (2011)



Sirius (2018) and Taiwan Photo Source (2015) have the same lattice as ALBA

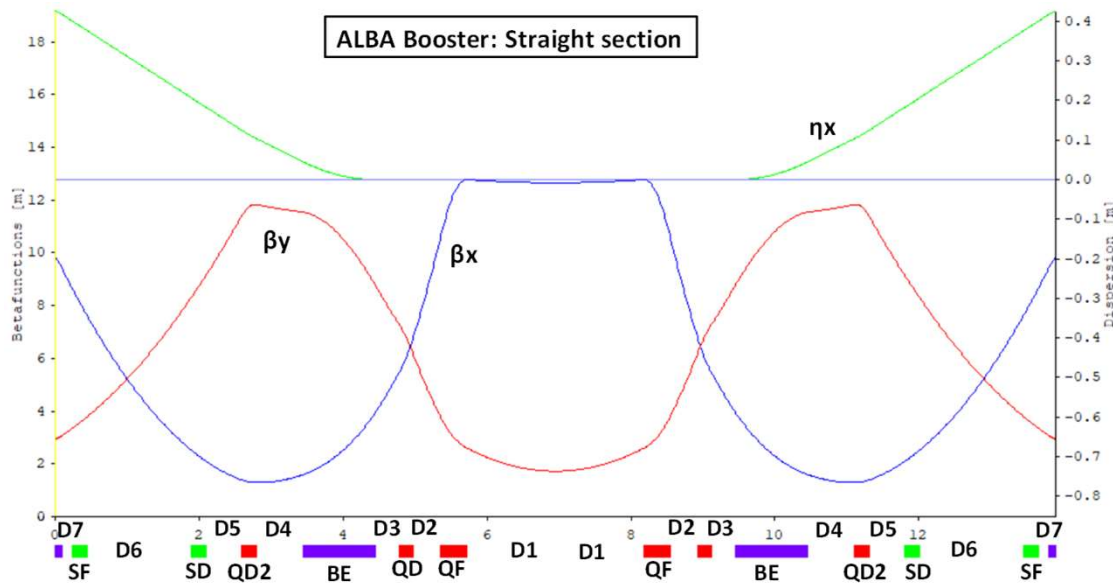


ALBA – Booster: Layout and Parameters

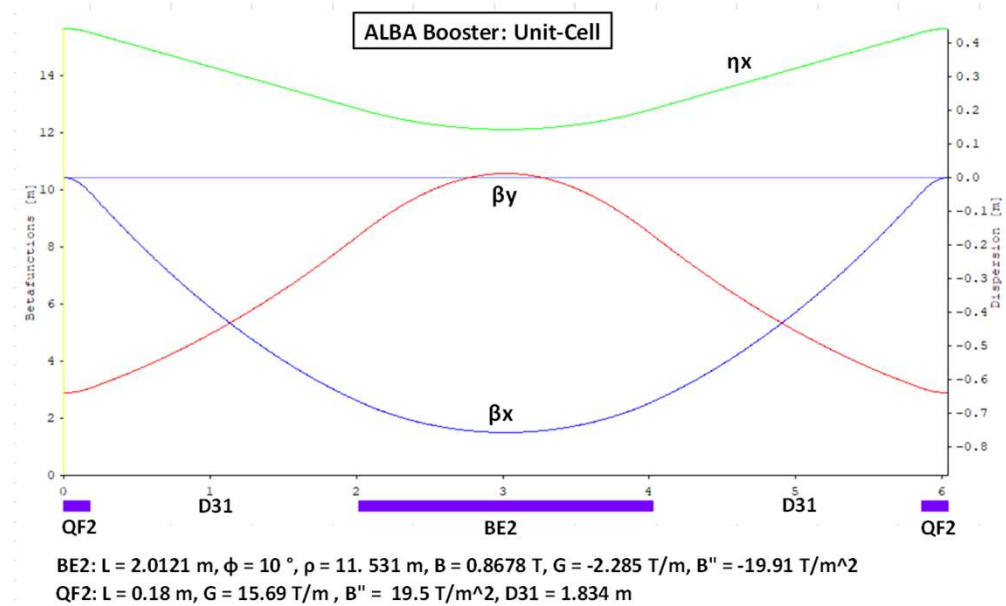


$E = 3 \text{ GeV}$, $C = 249.6 \text{ m}$, $I = > 5 \text{ mA}$, $\epsilon = 9 \text{ nrad}$
 $\xi_x = -16.7$, $\xi_x = -10.2$, $dE/\text{turn} = 622 \text{ keV}$

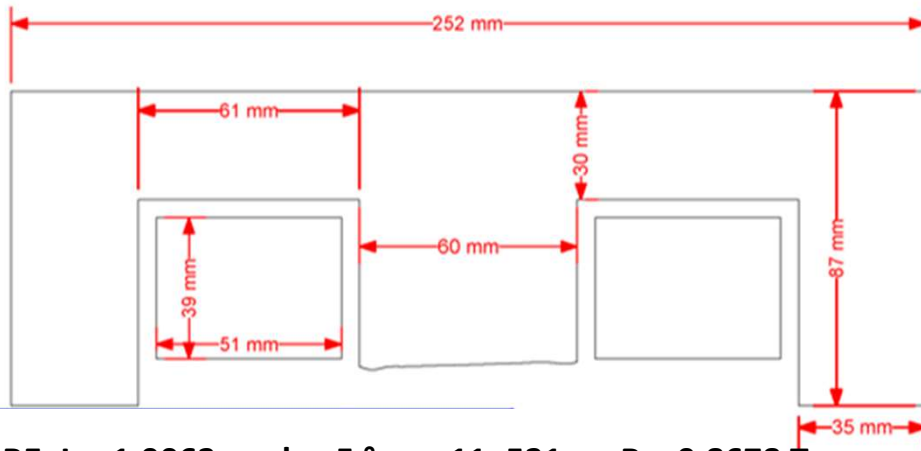
ALBA - Booster



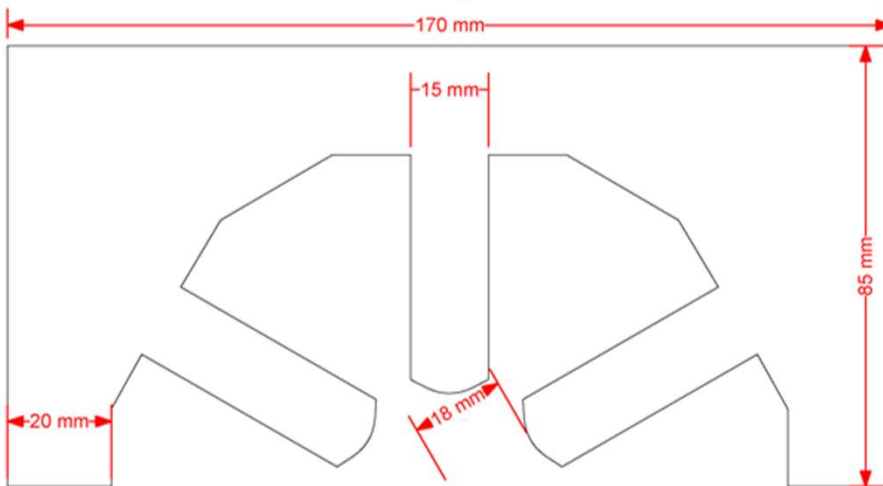
BE: $L = 1.0063$ m, $\phi = 5^\circ$, $\rho = 11.531$ m, $B = 0.8678$ T, $G = -2.285$ T/m, $B'' = -18.81$ T/m²
 QF: $L = 0.36$ m, $G = 14.08$ T/m, QD: $L = 0.2$ m, $G = -12.77$ T/m, QD2: $L = 0.2$ m, $G = -11.6$ T/m
 SF: $L = 0.2$ m, $B'' = 13.2$ T/m², SD: $L = 0.2$ m, $B'' = -37.4$ T/m²
 D1 = 1.23 m, D2 = 0.38 m, D3 = 0.3268 m, D4 = 0.4068 m, D5 = 0.5 m, D6 = 1.45 m, D7 = 0.15 m



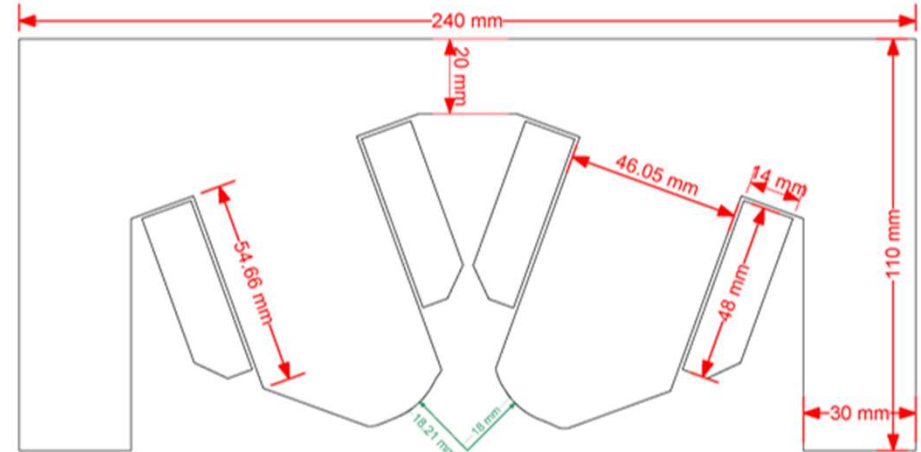
ALBA – Injector: Magnets



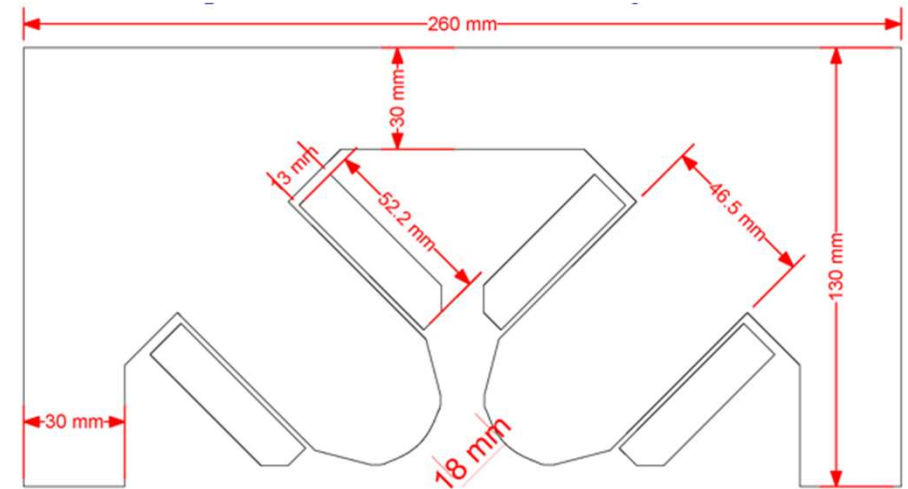
BE: $L = 1.0063 \text{ m}$, $\phi = 5^\circ$, $\rho = 11.531 \text{ m}$, $B = 0.8678 \text{ T}$,
 $G = -2.285 \text{ T/m}$, $B'' = -18.81 \text{ T/m}^2$



SD = 0.2 m , $B'' = -37.4 \text{ T/m}^2$



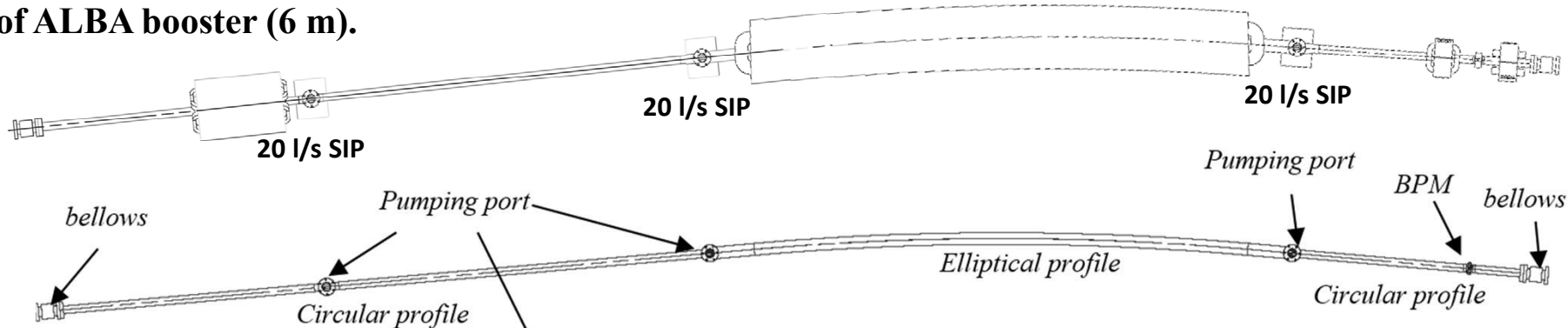
QF2: $L = 0.18 \text{ m}$, $G = 15.69 \text{ T/m}$, $B'' = 19.5 \text{ T/m}^2$



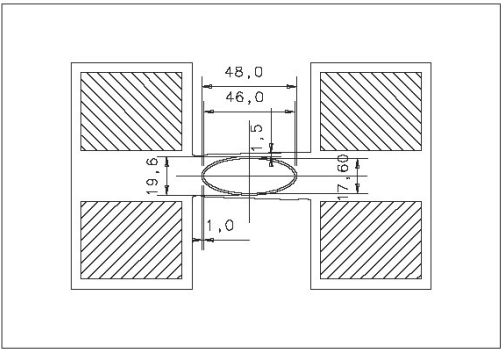
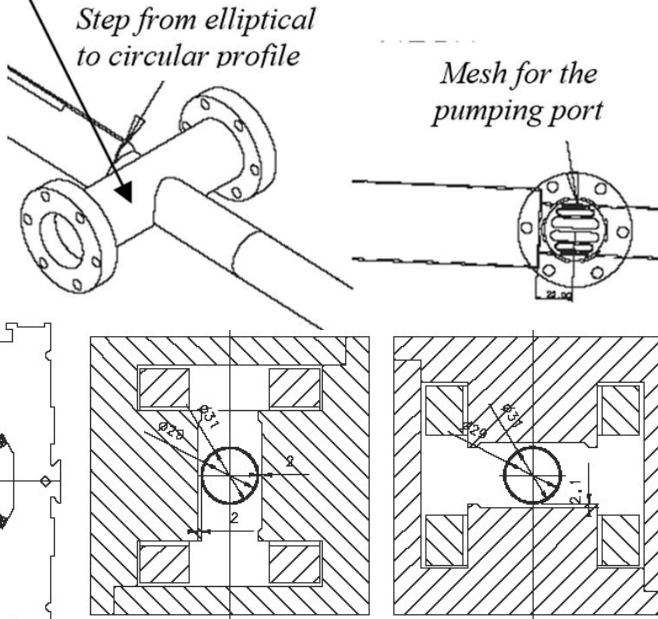
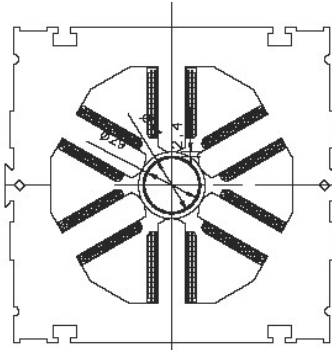
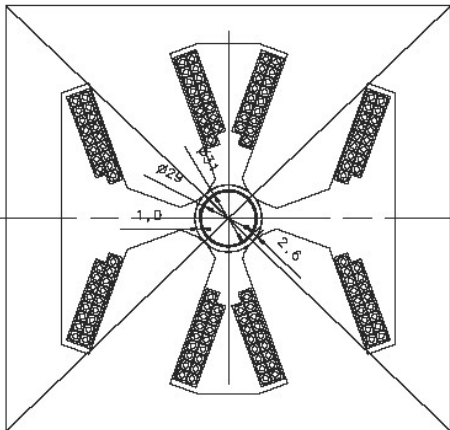
QF: $L = 0.36 \text{ m}$, $G = 14.08 \text{ T/m}$, QD: $L = 0.2 \text{ m}$, $G = -12.77 \text{ T/m}$,

ALBA – Booster Vacuum System

Unit cell of ALBA booster (6 m).



Inner vacuum chamber profile
Multipoles and correctors: 29 mm.



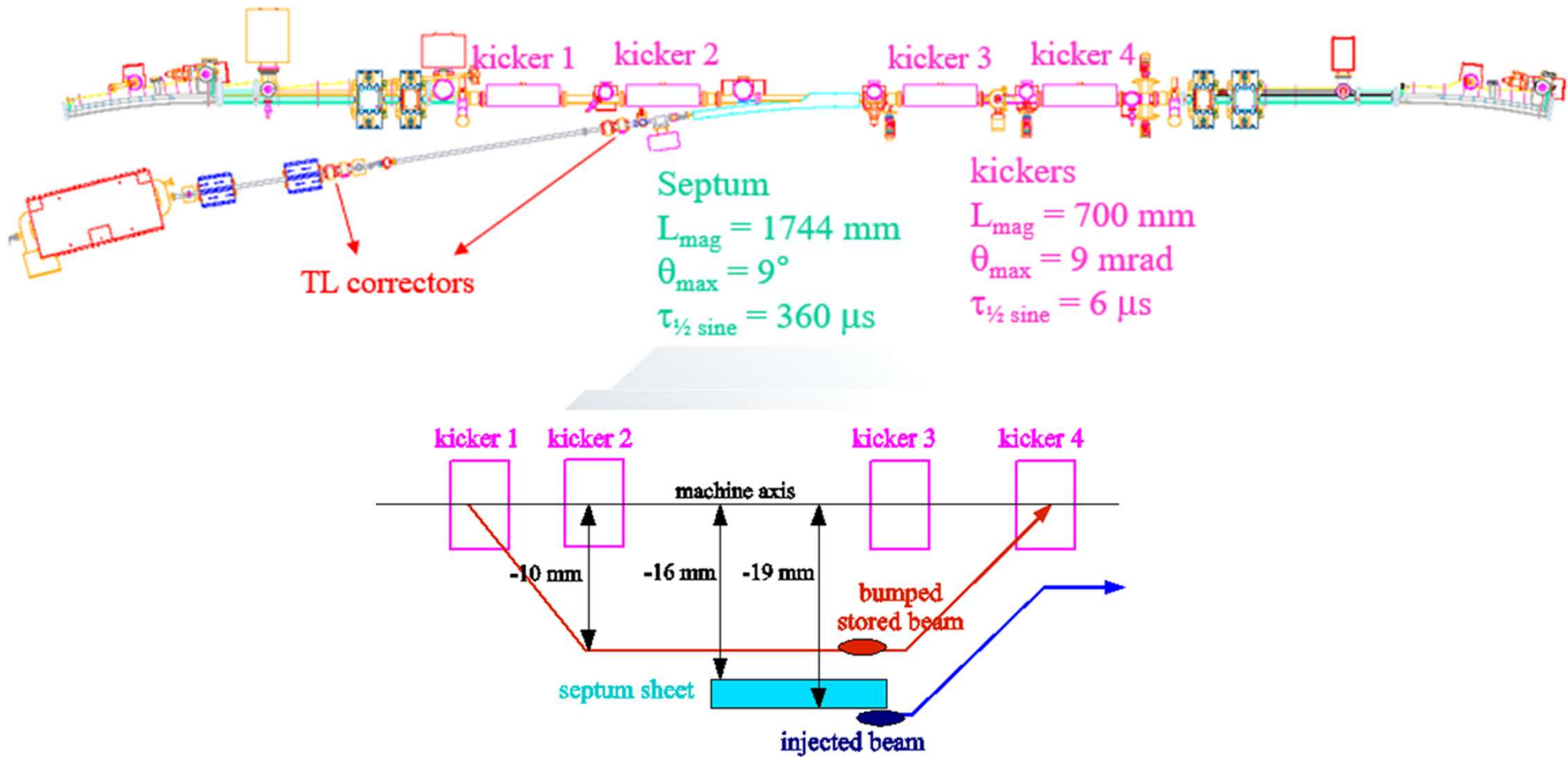
Inner vacuum chamber profile in the dipole is elliptical: 17.6 x 46mm

316l St. steel, 1 mm thickness.

ALBA – Injector



ALBA - Injector



SIRIUS - Injector

Many thanks to:

E. Al-Dmour (MAX IV), H. Bach (Danfysik. M. Böge (SLS), J.R. Calvey (APS), E. Huttel (KIT), J. Kallestrup (SLS), E. Karantzoulis (ELETTRA), I. Lohbrach (APS), M. Jordi (CELLS), L. Liu (LNLS), I. Martin (Diamond), M. McTeer (BESSY), R.T. Neuenschwander (LNLS), M. Pont (CELLS), Schulz (SLS), T. Shaftan (BNL), A. Shahveh (Diamond), Ch. Steier (ALS), M. Svandrlik (ELETTRA), E. Tan (ANSTO), P.F. Tavares (MAX IV), M.-A.-Tordeux

Many Thanks, Dieter