

High Performance Computing with Python

Ivan Kondov

STEINBUCH CENTRE FOR COMPUTING - SCC

Why using Python?

- Increase scientist's productivity
- Accelerate prototyping in complex projects
- Reuse existing codes written in any language

General strategies

- Detect performance critical sections using timing and profiling
- Performance irrelevant parts – program rapidly in Python
- Performance critical sections
 - Reuse available high performance libraries
 - Add your high performance codes as extension modules
- You are starting a new project – start it with Python

Disclaimer

- This is only a short introduction to HPC with Python
- No coverage of “basic” HPC and basic Python
- Many relevant aspects not covered – for example performance analysis

Overview

- General aspects
 - Python distributions
 - Virtual environments
- SciPy – the scientific package collection
- Concurrent and parallel programming/computing with Python
 - Python generators
 - Multiprocessing
 - Message passing
 - Workflows
- Heterogeneous programming/computing with Python
 - Linking to Fortran, C and C++
 - Just-in-time compiling (JIT)

Python distributions and venv

- CPython (the standard Python distribution)
 - bwUniCluster, bwForClusters
 - Versions available on bwUniCluster: 2.7, 3.3, 3.4, 3.5, 3.7
- Anaconda Python – focusing on scientific and engineering applications
- Intel Python
 - Based on Anaconda Python
 - Leverages Intel MKL, Intel TBB and Intel DAAL for high performance
 - Versions available on ForHLR-1 and ForHLR-2: 2.7, 3.5, 3.6
- Recommended Python versions: 3.x
- The most recent version: 3.7
- End of life of Python 2 in 2020
- Virtual environment (venv)
 - Isolated custom installation of python packages
 - Switching with commands “activate” and “deactivate”
 - For working with multiple projects with conflicting requirements

The SciPy collection

- NumPy – numerical computation with arrays
- SymPy – symbolic math computation
- SciPy library – a library for scientific computing
- Pandas – data analysis
- Matplotlib – data visualization
- IPython – interactive Python

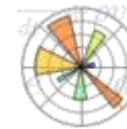
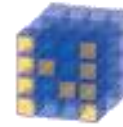

IP[y]:
IPython

Package	Module on bwUniCluster	Module on ForHLR-1 and ForHLR-2
Python	devel/python	devel/python
NumPy	numlib/python_numpy	devel/python
SciPy	numlib/python_scipy	devel/python
pandas	numlib/python_pandas	devel/python
Matplotlib	lib/matplotlib	devel/python
IPython	devel/ipython	devel/python

Exercise 1 on bwUniCluster

```
# prepare the global environment
module purge
module load devel/python/3.5.7
module load numlib/python_numpy/1.11.2-python-3.5.7

# create a virtual environment
python -m venv venv-python3

# activate the venv
. venv-python3/bin/activate
# deactivate the venv
deactivate
# activate again
. venv-python3/bin/activate

# pip should be kept up-to-date
pip install --upgrade pip
pip install sympy
```

Exercise 1 on ForHLR1 and ForHLR2

```
module purge
module load devel/python/3.5
python -m venv --without-pip [--system-site-packages] venv-python3
. venv-python3/bin/activate
pip install -t venv-python3/lib/python3.5/site-packages pip

# necessary for mpi4py but not available in venv (or not provided by intel)
python -m pip install setuptools

# not available in the venv
python -m pip install sympy
```

Exercise 2 on bwUniCluster

```
. venv-python3/bin/activate  
module load mpi/impi
```

```
# install mpi4py  
pip install mpi4py
```

```
# test the mpi4py installation  
mpiexec -n 3 python -m mpi4py.bench helloworld  
mpiexec -n 5 python -m mpi4py.bench ringtest -n 1024 -l 1000
```

```
# optional: run the unit tests (thousands of tests taking long time!)  
wget https://bitbucket.org/mpi4py/mpi4py/downloads/mpi4py-3.0.1.tar.gz  
tar xzf mpi4py-3.0.1.tar.gz  
cd mpi4py-3.0.1  
mpiexec -n 4 nosetests -w test
```

Exercise 2 on ForHLR1 and ForHLR2

```
deactivate
```

```
module purge
```

```
module load devel/python/3.5
```

```
. venv-python3/bin/activate
```

```
module load compiler/intel/18.0
```

```
module load mpi/impi/2018
```

```
python -m pip install mpi4py
```

```
mpirun -bootstrap ssh -n 3 python -m mpi4py.bench helloworld
```

```
mpirun -bootstrap ssh -n 5 python -m mpi4py.bench ringtest -n 1024 -l 1000
```

Python threads

- Concurrency versus parallelism
- Global Interpreter Lock (GIL)
- The `multithreading` package
- Preemptive multitasking

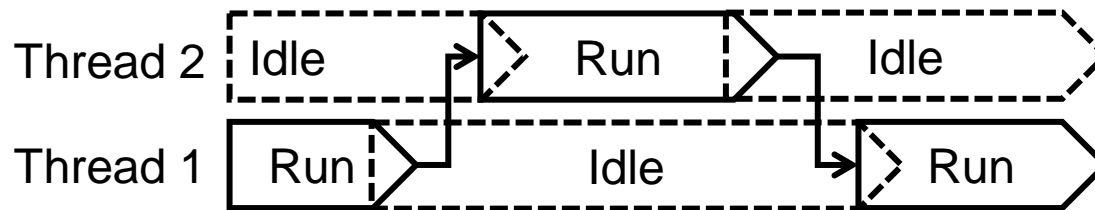

- Not relevant for HPC parallelization
- Relevant for processing I/O asynchronously (`asyncio` package)

Python generator

- Implemented concepts
 - Lazy evaluation / evaluation on demand
 - Cooperative multitasking
 - Iterator
- In data intensive computing
 - Save memory for IO operations
 - Save memory for intermediately stored objects
- Defined in different ways
 - Generator function: **yield** keyword
 - Generator expression using “()”
- Chains of generators - pipelines

```
def data_producer():  
    # do work  
    return lots_of_data
```

```
def data_consumer(data):  
    for element in data:  
        # do work
```

```
bulky = data_producer()  
result = data_consumer(bulky)
```

```
def smart_data_producer():  
    while is_working:  
        yield piece_of_data
```

```
gen = smart_data_producer()  
result = data_consumer(gen)
```

How does a generator work?

- The generator and consumer share the same processing element (PE)

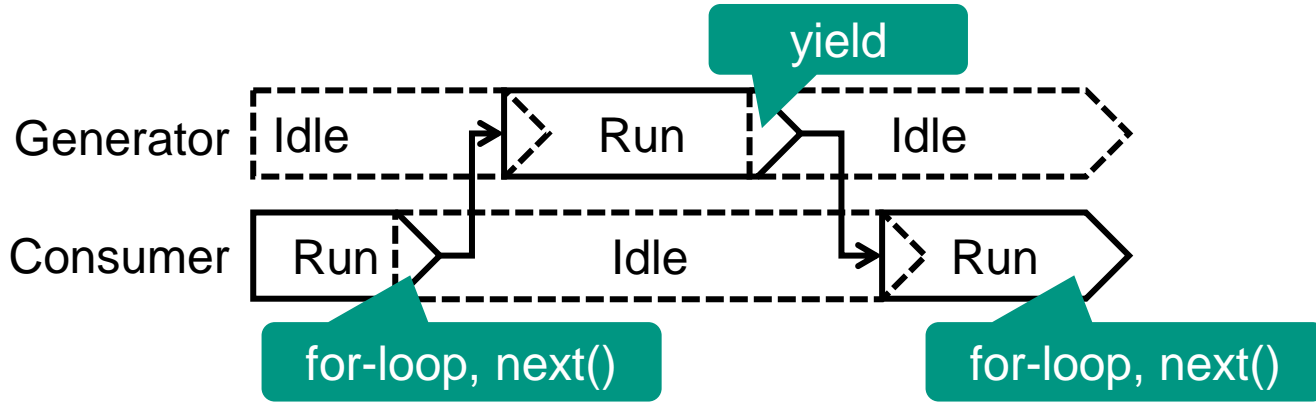

- The generator and consumer can be distributed on PEs
 - Task parallelism (MPSD)
 - Drawback: possible load imbalance

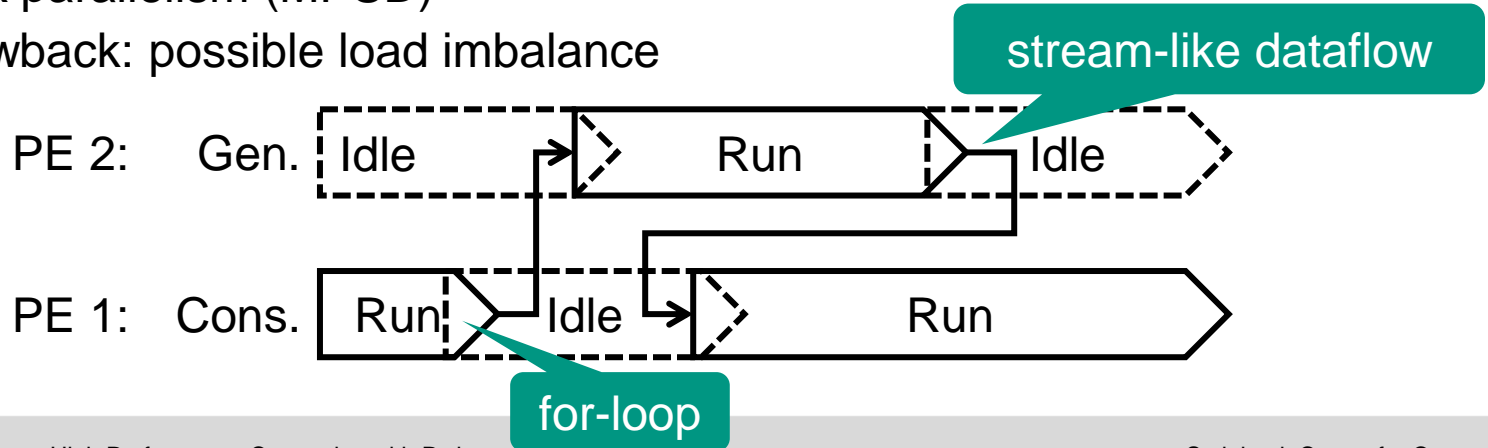

Exercise 3: Generators

- Calculate the first eight Fibonacci numbers
- Calculate the primes in a given range of numbers
- Find the first ten primes from the Fibonacci sequence

```
cd generator
```

```
# traditional method
```

```
python fib1.py
```

```
# infinite generator function
```

```
python fib2.py
```

```
# infinite iterator class
```

```
python fib3.py
```

```
# primes
```

```
python primes.py
```

```
# Fibonacci primes
```

```
python fibprimes.py
```

Data parallelism

- SPMD (Single Process Multiple Data) and MPMD
- Fine-grained vs. coarse grained parallelism

Package[.module[.class]]	Methods	Parallel	Many nodes
built-in/functools	map, filter, reduce	No	No
itertools	starmap	No	No
multiprocessing.Pool	map, map_async, imap, imap_unordered, starmap, starmap_async, apply, apply_async	Yes	No
concurrent.futures.ProcessPoolExecutor	map, submit, shutdown	Yes	No
mpi4py.futures.MPICommExecutor	map, starmap, submit, bootup, shutdown	Yes	Yes
mpi4py.futures.MPIPoolExecutor	map, starmap, submit, bootup, shutdown	Yes	Yes

The map method

$\text{Len}(\text{Data}) == N(P)$

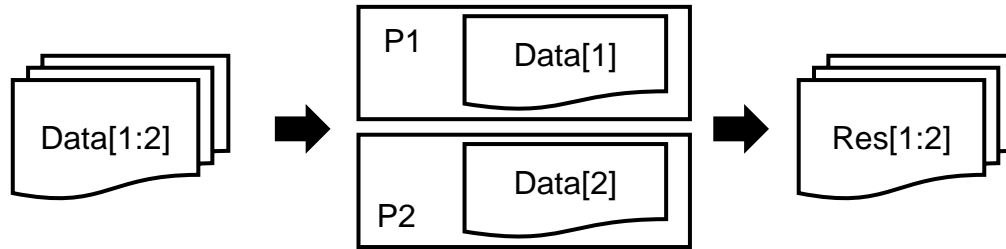

default chunk size == 1

$\text{Len}(\text{Data}) > N(P)$

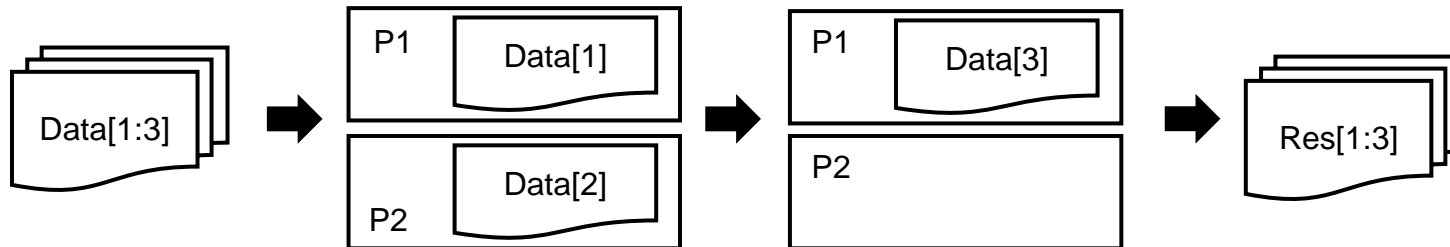

$\text{Len}(\text{Data}) > N(P)$ and chunk size == 2

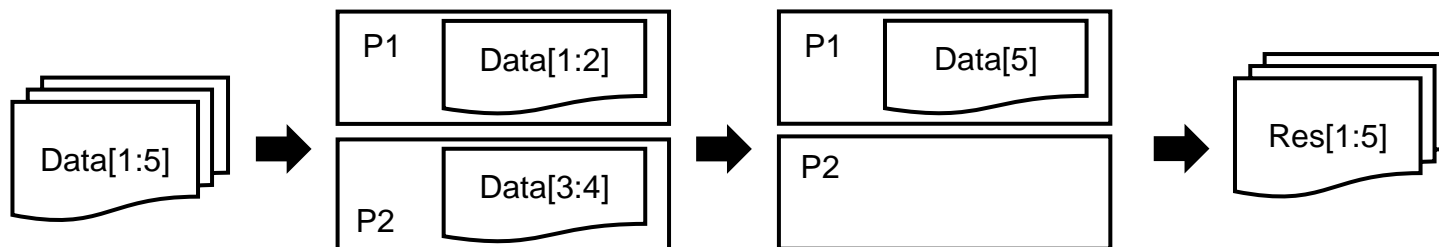

Exercise 4: Parallelizing the map method

- Find the primes from the first 5000 Fibonacci numbers
- Measure the run time with different parallelization packages, number of processes and chunk sizes

```
cd spmd
```

```
# serial  
python map.py
```

```
# multiprocessing package  
python multiprocessing_pool.py
```

```
# concurrent.futures package  
python process_pool_executor.py
```

```
# mpi4py package, static launch, 1 master, 4 workers  
mpiexec -n 5 python -m mpi4py mpi_comm_executor.py
```

```
# mpi4py package, dynamic launch (spawn), 1 master, up to 4 workers  
mpiexec -n 1 -usize 5 python -m mpi4py mpi_pool_executor.py
```

The mpi4py package

- Message passing: a paradigm for parallel computing
- Message Passing Interface (MPI) – the standard
- Allows distributed computing on many cluster nodes
- The mpi4py package – a python interface to MPI

- Point-to-point communication
 - Blocking send/recv
 - Non-blocking isend/irecv
- Collective communication: broadcast, scatter, gather, reduce, ...

- The item count and MPI datatype discovered automatically for
 - generic Python objects (lower-case methods)
 - numpy arrays with “standard datatypes” (upper-case methods)

Note on mpi4py runtime environment

- Usually the application is launched with

```
mpiexec -n <nprocs> python pyfile.py
```

- An unhandled exception (e.g. division by zero) may cause a deadlock
- Instead, there is a mechanism catching and handling such exceptions

```
mpiexec -n numprocs python -m mpi4py pyfile [arg] ...  
mpiexec -n numprocs python -m mpi4py -m mod [arg] ...  
mpiexec -n numprocs python -m mpi4py -c cmd [arg] ...  
mpiexec -n numprocs python -m mpi4py - [arg] ...
```

- Example

Exercise 5: Launching mpi4py programs

```
cd mpi4py
```

```
# the “standard” way
```

```
mpiexec -n 2 python deadlock.py
```

Why is there no deadlock if the exception occurs in rank 1?

```
# now the better way to launch
```

```
mpiexec -n 2 python -m mpi4py deadlock.py
```

Workflows versus pipelines

Workflow



- Step 2 begins after Step 1 is ready
- Data is passed discretely
- Directed acyclic graph: no loops

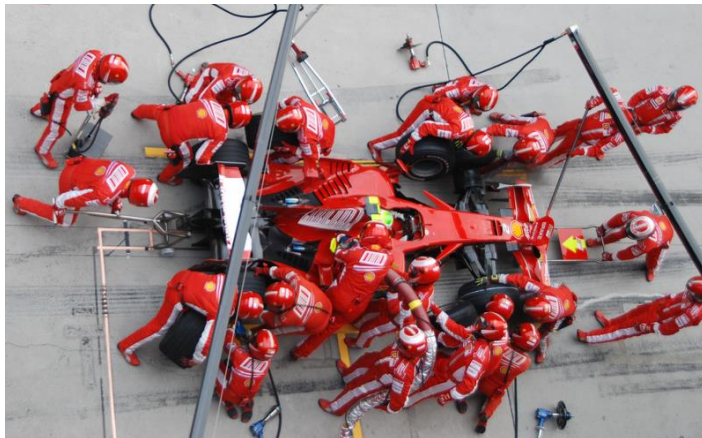

Source: Bert van Dijk, <https://www.flickr.com/photos/zilpho/2964165616>

fireworks, dask

Pipeline



- All stages run simultaneously
- Data is passed continuously
- Directed acyclic graph: no loops



Source: Ford Europe, <https://www.flickr.com/photos/fordeu/5709826282>

scikit-learn, python-pipes

Heterogeneous computing with Python

- Frameworks that compile optimized kernels
 - Theano – focus on multidimensional arrays and expressions
 - TensorFlow – focus on multidimensional arrays and dataflow
- Just-in-time (JIT) compilers
 - PyCUDA (NVIDIA GPU) <https://document.tician.de/pycuda>
 - PyOpenCL (CPU/GPU) <https://document.tician.de/pyopencl>
 - Numba (CPU/GPU) <http://numba.pydata.org>
 - Pythran (CPU) <https://pythran.readthedocs.io>
- Linking to C, C++ and Fortran

Linking to C, C++ and Fortran

- External codes can be linked as extension modules
- Main approach: write or generate a wrapper

Name	Language	Approach	Web site
Python/C API	C	API (Python.h)	docs.python.org
ctypes	C, C++	Link to DLLs	docs.python.org
Boost.Python	C++	API	www.boost.org
SWIG	C, C++	compiler	www.swig.org
F2PY	C, Fortran	compiler wrapper	docs.scipy.org
Pyrex/Cython	C	language / compiler	cython.org

Exercise 6: Linking to C++ and Fortran

- Link to C++ using ctypes
 - given the class definition in `fib.cpp`
 - write an extension interface `fib_ext.cpp`
 - write an extension module `fib.py`

```
cd ctypes
make fibc++.so
python fibtest.py
```

- Link to Fortran using f2py
 - automatic building an extension module using module `numpy.f2py`
 - on ForHLR* add “`--fcompiler=intelem`” after “`-c`” in makefile

```
cd f2py
# compile and run the Fortran 77 program
make fibprog && ./fibprog
```

- Case 1: Link to `libfib1` with no explicit interface

```
make libfib1
python fib1.py
```

Creating explicit interfaces to Fortran

■ Case 2: Adapting the interface using a pyf-file

```
make fib1pyf
# open fib1.pyf and change
  integer dimension(n) :: a
  integer, optional, check(len(a)>=n), depend(a) :: n=len(a)
# with
  integer dimension(n), intent(out), depend(n) :: a
  integer, intent(in) :: n
# and save as fib2.pyf
make libfib2
python fib2.py
```

■ Case 3: Instrumenting the Fortran source

```
# add to the end of the header of the fib subroutine
cf2py intent(out) a
cf2py depend(n) a
cf2py intent(in) n
make libfib3
python fib3.py
```

Using explicit interfaces to Fortran

- Case 4: Linking to Fortran 90
 - No changes necessary – just use the Fortran 90 modules and interfaces
 - Result the same as in Cases 2 and 3
 - Example in file `fib4.f90`

```
make libfib4  
python fib4.py
```